



A/C mobile refrigeration



MAFLOW



Mobile Refrigeration Hose-Fittings



MAFLOW World Wide Presence





INTRODUCTION

Maflow Boryszew Group is one of the largest manufacturers of fluid handling systems for automotive applications.

Maflow Boryszew Group is skilled in the production of flexible reinforced rubber hoses in order to satisfy the growing demands and expectations of the automotive market, granting top quality products.



INTRODUZIONE

Maflow Boryszew Group è uno dei più grandi produttori di sistemi per passaggio fluidi nelle applicazioni automobilistiche.

Maflow Boryszew Group è specializzato nella produzione di tubi in gomma flessibili rinforzati al fine di soddisfare le richieste e le aspettative del mercato automobilistico garantendo la più alta qualità dei prodotti.



EINFÜHRUNG

Die Maflow Boryszew Gruppe ist einer der weltweit größten Hersteller von Flüssigkeitsleitsystemen für die Automobilindustrie und ist spezialisiert auf die Produktion von flexiblen und verstärkten Gummischläuchen, um den wachsenden Anforderungen und Erwartungen des Automobilmarktes gerecht zu werden. Die Gruppe garantiert höchste Qualität und beste Ausführung unserer Produkte.



INTRODUCTION

Le groupe Maflow Boryszew est l'un des plus grands fabricants, dans le secteur automobile, de flexibles pour les circuits de réfrigération.

Le groupe Maflow Boryszew est spécialisé dans la production de flexibles en caoutchouc renforcé, de raccords et d'assemblages afin de répondre aux demandes et aux attentes du marché automobile, pour lequel nous garantissons la plus haute qualité de nos produits.

INTRODUCCIÓN



INTRODUCCIÓN

El Grupo Maflow Boryszew es uno de los mayores fabricantes de sistemas de conducción de líquidos y gases para todas las aplicaciones del automóvil.

El Grupo Maflow Boryszew es especialista en la producción de tuberías flexibles reforzadas, para satisfacer las crecientes demandas y expectativas del mercado de la automoción. El Grupo Maflow Boryszew garantiza la máxima calidad de todos sus productos.



TANITIM

Maflow Boryszew Group tüm otomotiv sektörü için araç akıkan sistemleri uygulamaları alanında en büyük üreticilerden biridir.

Firmamız otomotiv pazarının artan talep ve kalite beklentilerini karşılamak amacıyla elastik, takviyeli kauçuk bağlantıların üretimi konusunda uzmanlamıştır.

Maflow Boryszew Group olarak ürünlerimizin en yüksek kalitede olduğunu garanti ederiz.

MAFLOW - Ascoli Piceno, Italy





Production



Laboratories





INDEX INDICE ÍNDICE

GHIBLI - Hose data sheet Scheda tecnica del tubo Ficha de datos de la tubería	15
FASTCLIC fittings - Raccordi FASTCLIC - Racores FASTCLIC	16-27
Accessories - Accessori - Accesorios	28
Assembly instruction - Istruzioni di montaggio - Instrucciones de montaje	29
MAESTRALE - Hose data sheet Scheda tecnica del tubo Ficha de datos de la tubería	31
MISTRAL - Hose data sheet Scheda tecnica del tubo Ficha de datos de la tubería	32
SCM Reusable fittings - Raccordi SCM recuperabili - Racores SCM reutilizable	33-42
Assembly instruction - Istruzioni di montaggio - Instrucciones de montaje	43
GLACIER - Hose data sheet Scheda tecnica del tubo Ficha de datos de la tubería	45
ICEBERG - Hose data sheet Scheda tecnica del tubo Ficha de datos de la tubería	46
BLIZZARD - Hose data sheet Scheda tecnica del tubo Ficha de datos de la tubería	47
Crimping fittings - Raccordi a crimpare - Racores para engastar	48-60
MAC-SERVICE - Hose data sheet Scheda tecnica del tubo Ficha de datos de la tubería	63
ARTIC NK - Hose data sheet Scheda tecnica del tubo Ficha de datos de la tubería	65

Hose Selection Chart Mobile Refrigeration

Hose Name								Materials								SAE J3062 / J2064 Type							
Size [ID mm]																							
8	10	13	16	19	22	28																	
Veneer																							
GHIBLI								>PA-EPDM<								 E							
<input checked="" type="checkbox"/>	<input checked="" type="checkbox"/>	<input checked="" type="checkbox"/>	<input checked="" type="checkbox"/>	<input type="checkbox"/>	<input checked="" type="checkbox"/>	<input checked="" type="checkbox"/>	Rnf: Textile																
Barrier																							
BLIZZARD								>EPDM-PA-EPDM<								 C							
<input checked="" type="checkbox"/>	<input checked="" type="checkbox"/>	<input checked="" type="checkbox"/>	<input checked="" type="checkbox"/>	<input checked="" type="checkbox"/>	<input type="checkbox"/>	<input type="checkbox"/>	Rnf: Textile																
ICEBERG								>EPDM-PA-EPDM<															
<input checked="" type="checkbox"/>	<input checked="" type="checkbox"/>	<input checked="" type="checkbox"/>	<input checked="" type="checkbox"/>	<input type="checkbox"/>	<input type="checkbox"/>	<input type="checkbox"/>	Rnf: Textile																
MAC-SERVICE								>EPDM-PA-EPDM<															
6mm																							
<input checked="" type="checkbox"/>	<input type="checkbox"/>	<input type="checkbox"/>	<input type="checkbox"/>	<input type="checkbox"/>	<input type="checkbox"/>	<input type="checkbox"/>	Rnf: Textile																
All Rubber																							
GLACIER								>IIR-EPDM<								 A							
<input checked="" type="checkbox"/>	<input checked="" type="checkbox"/>	<input checked="" type="checkbox"/>	<input checked="" type="checkbox"/>	<input checked="" type="checkbox"/>	<input type="checkbox"/>	<input type="checkbox"/>	Rnf: Textile																
Wire Reinf. - All Rubber																							
MAESTRALE								>IIR-CSM<								 B							
<input checked="" type="checkbox"/>	<input checked="" type="checkbox"/>	<input checked="" type="checkbox"/>	<input checked="" type="checkbox"/>	<input checked="" type="checkbox"/>	<input checked="" type="checkbox"/>	<input checked="" type="checkbox"/>	Rnf: Steel																
Wire Reinf. - Barrier																							
MISTRAL								>EPDM-PA-CSM<								 C/B							
<input type="checkbox"/>	<input type="checkbox"/>	<input type="checkbox"/>	<input type="checkbox"/>	<input type="checkbox"/>	<input checked="" type="checkbox"/>	<input checked="" type="checkbox"/>	Rnf: Steel																

Mobile Refrigeration Hose RANGE

Key Characteristics													Fitting						
Temperature Resist.		Permeability SAE 80°C	PAG Compati POE bility	Noise Damping	Flexibility	Bending Radius	Compactness	Fatigue Resistance	Robustness	Type	Mount ability	Reus ability							
-40°C	-20°C	...	100°C	110°C	120°C	130°C	140°C	150°C	160°C										
-40	...	25	150	20_kg/m³/y	E	E	E	E	E	E	E	G	E	Maflow Fast Clic	E	Nipple Yes			
-40	...	25	150	20_kg/m³/y	E+	E	G	G	G	E	E	E	E	Crimp fitting	G	No			
-40	...	25	140	20_kg/m³/y	E	E	G	G	G	G	G	G	E	Crimp fitting	E	No			
-40	...	25	150	20_kg/m³/y	E	E	G	E	E	E	E	E	E	Crimp fitting	E	No			
-40	...	10	140	20_kg/m³/y	G	E	G	E+	E	G	G	G	E	Crimp fitting	E	No			
-40	...	10	140	20_kg/m³/y	G	E	G	G	F	F	G	E	E+	SCM fitting	F	Yes			
-40	...	25	150	20_kg/m³/y	E+	E	G	G	F	F	G	E	E+	SCM fitting	F	Yes			

E+ = Very Excellent; E = Excellent; G = Good; F = Fair; C = Conditional



GHIBLI

FASTCLIC FITTING - RACCORDI FASTCLIC - RACORES FASTCLIC

ACCESSORIES - ACCESSORI - ACCESORIOS

Assembly instruction - Istruzioni di montaggio - Instrucciones de montaje

G H I B L I



Hose Type	G H I B L I
Application	AIR CONDITIONING SYSTEMS
Specification (qualifications list is not excluding further specs.)	SAE J2064 Type E
Working Temp.	- 40 ÷ 125°C

Peak Temp.	140°C
Tube	PA
Reinforcement	1 textile braid
Cover	EPDM
Key characteristics	<ul style="list-style-type: none"> - Low Permeability to Refrigerant Fluids; - Compatibility with a wide range of refrigerants such as R134a, R1234yf, R404a; - High Flexibility; Low Noise Transmission; - Couplable with FASTCLIC fittings also

DIMENSIONS AND TOLERANCES

DN [mm] ID OD	Size [inch]	Hose ID [mm]		Hose OD [mm]		Max wall th. difference [mm]
		min	max	min	max	
8,0 x 16,0	5/16	7,7	8,3	15,5	16,5	0,4
10,7 x 18,8	13/32	10,4	11,0	18,3	19,3	0,5
12,7 x 21,5	1/2	12,4	13,0	21,0	22,0	0,5
16,1 x 24,1	5/8	15,7	16,5	23,6	24,6	0,6
22,0 x 31,0	7/8	21,6	22,4	30,4	31,6	0,7
28,0 x 37,0	11/8	27,4	28,6	36,3	37,7	0,7

TECHNICAL CHARACTERISTICS

DN (mm) ID OD	Working pressure [bar]	Burst pressure [bar]	Minimum bend radius [mm]	Weight [g/m]	Ultra Low Perm. to R1234yf [kg/m ² /y]
10,7 x 18,8	35	>180	50	210	< 1,5
12,7 x 21,5	35	>180	60	270	< 1,5
16,1 x 24,1	20	>180	70	290	< 1,5
22,0 x 31,0	20	>140	100	430	< 1,5
28,0 x 37,0	20	>100	130	530	< 1,5

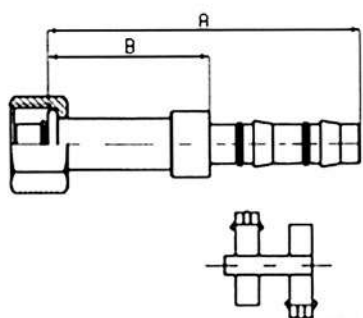

**FASTCLIC FITTING 180° FEMALE OR
RACCORDO FASTCLIC 180° FEMMINA OR**

CODICE CODE	TUBO HOSE	FILETTATURA THREADING	A	B
	size - dn - inch			
MRB1436	06 - 8 - 5/16"	5/8" - 18 UNF	95	55
MRB1439	08 - 10 - 13/32"	5/8" - 18 UNF	95	55
MRB1415	06 - 8 - 5/16"	3/4" - 16 UNF	95	55
MRB1438	08 - 10 - 13/32"	3/4" - 16 UNF	95	55
MRB1441	10 - 13 - 1/2"	3/4" - 16 UNF	95	55
MRB1440	10 - 13 - 1/2"	7/8" - 14 UNF	95	55
MRB1437	12 - 16 - 5/8"	7/8" - 14 UNF	95	55
MRB1411	10 - 13 - 1/2"	1"1/16 - 14 UNS	95	55
MRB1442	12 - 16 - 5/8"	1"1/16 - 14 UNS	95	55

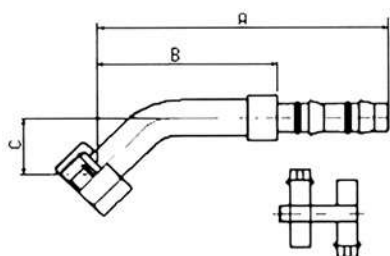

**FASTCLIC FITTING 45° FEMALE OR
RACCORDO FASTCLIC 45° FEMMINA OR**

CODICE CODE	TUBO HOSE	FILETTATURA THREADING	A	B	C
	size - dn - inch				
MRB1446	06 - 8 - 5/16"	5/8" - 18 UNF	80	40	13
MRB1448	08 - 10 - 13/32"	3/4" - 16 UNF	90	50	18
MRB1444	10 - 13 - 1/2"	3/4" - 16 UNF	90	50	18
MRB1450	10 - 13 - 1/2"	7/8" - 14 UNF	110	70	26
MRB1434	12 - 16 - 5/8"	7/8" - 14 UNF	110	70	26
MRB1452	12 - 16 - 5/8"	1"1/16 - 14 UNS	110	70	26

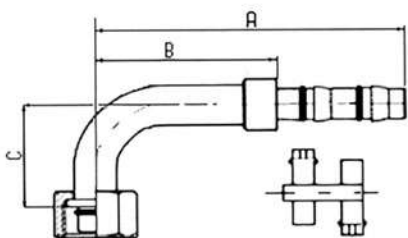

**FASTCLIC FITTING 90° FEMALE OR
RACCORDO FASTCLIC 90° FEMMINA OR**

CODICE CODE	TUBO HOSE	FILETTATURA THREADING	A	B	C
	size - dn - inch				
MRB1456	06 - 8 - 5/16"	5/8" - 18 UNF	72	32	28
MRB1477	08 - 10 - 13/32"	5/8" - 18 UNF	72	32	30
MRB1476	06 - 8 - 5/16"	3/4" - 16 UNF	85	45	30
MRB1458	08 - 10 - 13/32"	3/4" - 16 UNF	85	45	30
MRB1465	10 - 13 - 1/2"	3/4" - 16 UNF	85	45	30
MRB1460	10 - 13 - 1/2"	7/8" - 14 UNF	105	65	45
MRB1467	12 - 16 - 5/8"	7/8" - 14 UNF	105	65	45
MRB1462	12 - 16 - 5/8"	1.1/16" - 14 UNS	105	65	50
MRB1804	16 - 22 - 7/8"	1.1/16" - 14 UNS	105	65	52

**FASTCLIC 180° FASTCLIC MALE OR
RACCORDO FASTCLIC 180° MASCHIO OR**

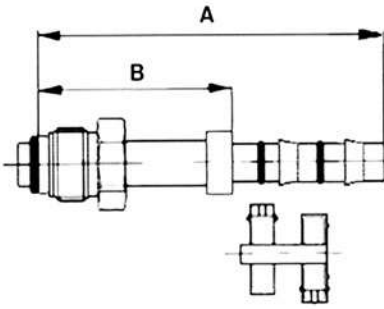

CODICE CODE	TUBO HOSE	FILETTATURA THREADING	A	B
	size - dn - inch			
MRB1496	06 - 8 - 5/16"	5/8" - 18 UNF	85	45
MRB1502	08 - 10 - 13/32"	5/8" - 18 UNF	85	45
MRB1498	08 - 10 - 13/32"	3/4" - 18 UNS	85	45
MRB1500	10 - 13 - 1/2"	7/8" - 18 UNS	85	45
MRB1503	12 - 16 - 5/8"	7/8" - 18 UNS	85	45

**FASTCLIC FITTING 45° MALE OR
RACCORDO FASTCLIC 45° MASCHIO OR**

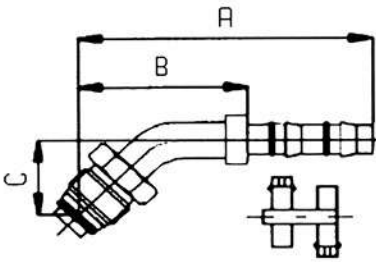

CODICE CODE	TUBO HOSE	FILETTATURA THREADING	A	B	C
	size - dn - inch				
MRB1506	06 - 8 - 5/16"	5/8" - 18 UNF	85	45	18
MRB1504	08 - 10 - 13/32"	5/8" - 18 UNF	95	55	23
MRB1508	08 - 10 - 13/32"	3/4" - 18 UNS	95	55	23
MRB1510	10 - 13 - 1/2"	7/8" - 18 UNS	115	75	31
MRB1505	12 - 16 - 5/8"	7/8" - 18 UNS	115	75	31

**FASTCLIC FITTING 90° MALE OR
RACCORDO FASTCLIC 90° MASCHIO OR**

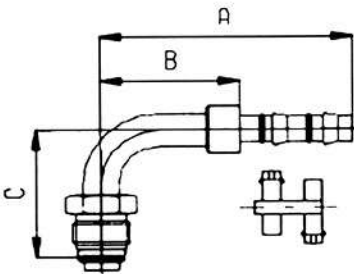

CODICE CODE	TUBO HOSE	FILETTATURA THREADING	A	B	C
	size - dn - inch				
MRB1516	06 - 8 - 5/16"	5/8" - 18 UNF	72	32	41
MRB1509	08 - 10 - 13/32"	5/8" - 18UNF	72	32	41
MRB1518	08 - 10 - 13/32"	3/4" - 18 UNS	87	47	54
MRB1520	10 - 13 - 1/2"	7/8" - 18 UNS	87	47	54
MRB1511	12 - 16 - 5/8"	7/8" - 18 UNS	87	47	54

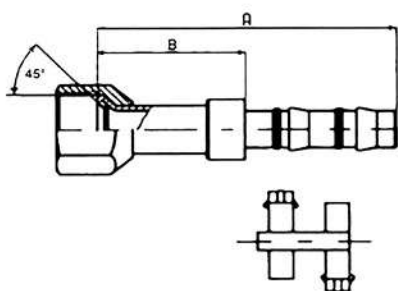

FASTCLIC FITTING 180° WITH FEMALE FLARE
RACCORDO FASTCLIC 180° FEMMINA CONO

CODICE CODE	TUBO HOSE	FILETTATURA THREADING	A	B
	size - dn - inch			
MRB1429	06 - 8 - 5/16"	7/16" - 20 UNF	85	45
MRB1406	06 - 8 - 5/16"	5/8" - 18 UNF	85	45
MRB1403	08 - 10 - 13/32"	5/8" - 18 UNF	85	45
MRB1408	08 - 10 - 13/32"	3/4" - 16 UNF	85	45
MRB1404	10 - 13 - 1/2"	3/4" - 16 UNF	85	45
MRB1410	10 - 13 - 1/2"	7/8" - 14 UNF	85	45
MRB1405	12 - 16 - 5/8"	7/8" - 14 UNF	85	45
MRB1412	12 - 16 - 5/8"	1"1/16 - 14 UNS	85	45

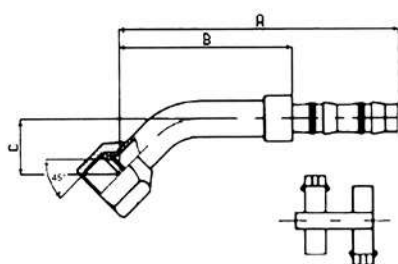

FASTCLIC FITTING 45° WITH FEMALE FLARE
RACCORDO FASTCLIC 45° FEMMINA CONO

CODICE CODE	TUBO HOSE	FILETTATURA THREADING	A	B	C
	size - dn - inch				
MRB1417	06 - 8 - 5/16"	7/16" - 20 UNF	80	40	12
MRB1416	06 - 8 - 5/16"	5/8" - 18 UNF	80	40	12
MRB1418	08 - 10 - 13/32"	3/4" - 16 UNF	90	50	15
MRB1419	10 - 13 - 1/2"	3/4" - 16 UNF	90	50	15
MRB1420	10 - 13 - 1/2"	7/8" - 14 UNF	115	75	20
MRB1421	12 - 16 - 5/8"	7/8" - 14 UNF	115	75	20
MRB1422	12 - 16 - 5/8"	1"1/16 - 14 UNS	115	75	20

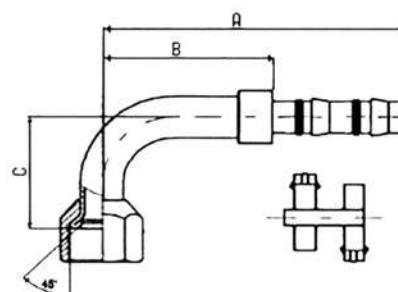

FASTCLIC FITTING 90° WITH FEMALE FLARE
RACCORDO FASTCLIC 90° FEMMINA CONO

CODICE CODE	TUBO HOSE	FILETTATURA THREADING	A	B	C
	size - dn - inch				
MRB1427	06 - 8 - 5/16"	7/16" - 20 UNF	80	40	27
MRB1426	06 - 8 - 5/16"	5/8" - 18 UNF	80	40	27
MRB1425	08 - 10 - 13/32"	5/8" - 18 UNF	80	40	27
MRB1428	08 - 10 - 13/32"	3/4" - 16 UNF	85	45	35
MRB1433	10 - 13 - 1/2"	3/4" - 16 UNF	85	45	35
MRB1430	10 - 13 - 1/2"	7/8" - 14 UNF	100	60	45
MRB1431	12 - 16 - 5/8"	7/8" - 14 UNF	100	60	45
MRB1432	12 - 16 - 5/8"	1"1/16 - 14 UNS	100	60	45

**FASTCLIC FITTING 180° FEMALE OR ROTALOCK
RACCORDO FASTCLIC 180° OR ROTALOCK**

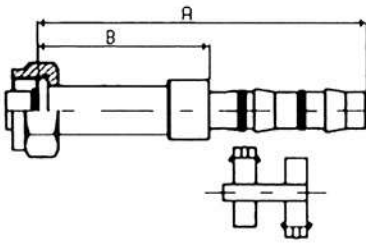

CODICE CODE	TUBO HOSE	FILETTATURA THREADING	A	B
	size - dn - inch			
MRB1468	08 - 10 - 13/32"	1"-14 UNS-2B	95	55
MRB1470	10 - 13 - 1/2"	1"-14 UNS 2B	95	55
MRB1472	12 - 16 - 5/8"	1"-14 UNS 2B	95	55

**FASTCLIC FITTING 45° FEMALE OR ROTALOCK
RACCORDO FASTCLIC 45° FEMMINA OR ROTALOCK**

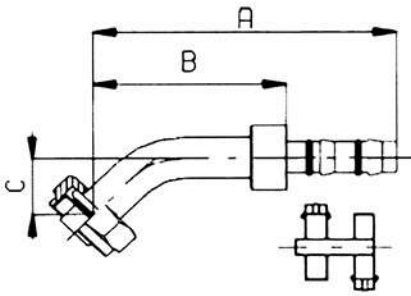

CODICE CODE	TUBO HOSE	FILETTATURA THREADING	A	B	C
	size - dn - inch				
MRB1478	08 - 10 - 13/32"	1"-14 UNS -2B	110	70	30
MRB1480	10 - 13 - 1/2"	1"-14 UNS -2B	110	70	30
MRB1482	12 - 16 - 5/8"	1"-14 UNS -2B	110	70	30

**FASTCLIC FITTING 90° FEMALE OR ROTALOC
RACCORDO FASTCLIC 90° FEMMINA OR ROTALOCK**

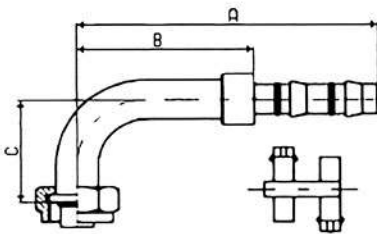

CODICE CODE	TUBO HOSE	FILETTATURA THREADING	A	B	C
	size - dn - inch				
MRB1488	08 - 10 - 13/32"	1"-14 UNS -2B	105	65	48
MRB1490	10 - 13 - 1/2"	1"-14 UNS -2B	105	65	48
MRB1492	12 - 16 - 5/8"	1"-14 UNS -2B	105	65	48

FASTCLIC FITTING 180° FEMALE ORS FLAT SEAT
RACCORDO FASTCLIC 180° FEMMINA ORS - TENUTA FRONTALE

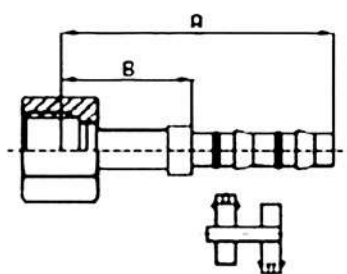

CODICE CODE	TUBO HOSE	FILETTATURA THREADING	A	B
	size - dn - inch			
MRB1454	06 - 8 - 5/16"	9/16" - 18	80	40
MRB1455	06 - 8 - 5/16"	11/16" - 16	80	40
MRB1459	08 - 10 - 13/32"	13/16" - 16	80	40
MRB1544	10 - 13 - 1/2"	13/16" - 16	80	40
MRB1443	10 - 13 - 1/2"	1" - 14	80	40
MRB1463	12 - 16 - 5/8"	1 3/16" - 12	80	40

FASTCLIC FITTING 45° FEMALE ORS - FLAT SEAT
RACCORDO FASTCLIC 45° FEMMINA ORS - TENUTA FRONTALE

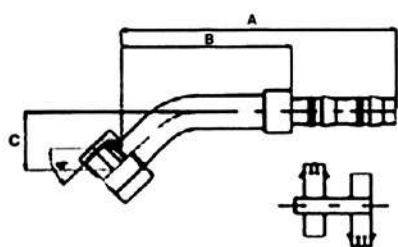

CODICE CODE	TUBO HOSE	FILETTATURA THREADING	A	B	C
	size - dn - inch				
MRB1481	06 - 8 - 5/16"	9/16" - 18	80	40	15
MRB1483	06 - 8 - 5/16"	11/16" - 16	80	40	15
MRB1545	08 - 10 - 13/32"	13/16" - 16	90	50	18
MRB1484	10 - 13 - 1/2"	13/16" - 16	115	75	22
MRB1485	10 - 13 - 1/2"	1" - 14	115	75	22
MRB1486	12 - 16 - 5/8"	1 3/16" - 12	115	75	22

FASTCLIC FITTING 90° FEMALE ORS - FLAT SEAT
RACCORDO FASTCLIC 90° FEMMINA ORS - TENUTA FRONTALE

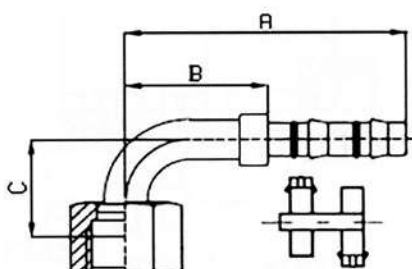

CODICE CODE	TUBO HOSE	FILETTATURA THREADING	A	B	C
	size - dn - inch				
MRB1457	06 - 8 - 5/16"	9/16" - 18	80	40	45
MRB1453	06 - 8 - 5/16"	11/16" - 16	80	40	45
MRB1413	06 - 8 - 5/16"	13/16" - 16	80	40	45
MRB1451	08 - 10 - 13/32"	13/16" - 16	80	40	45
MRB1469	10 - 13 - 1/2"	13/16" - 16	80	40	45
MRB1445	10 - 13 - 1/2"	1" - 14	80	40	45
MRB1414	12 - 16 - 5/8"	1" - 14	80	40	45
MRB1461	12 - 16 - 5/8"	1 3/16" - 12	80	40	45

**COMPACT FASTCLIC FITTING 90° ROTALOCK FEMALE OR
RACCORDO FASTCLIC 90° COMPATTO ROTALOCK FEMMINA OR**

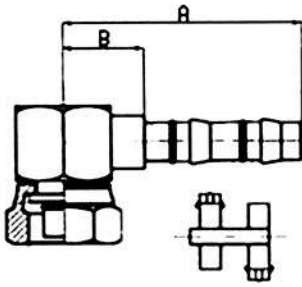

CODICE CODE	TUBO HOSE	FILETTATURA THREADING	A	B
	size - dn - inch			
MRB1495	08 - 10 - 13/32"	3/4" - 16 UNF - 2B	72	40
MRB1598	08 - 10 - 13/32"	1" - 14 UNS - 2B	80	40
MRB1497	10 - 13 - 1/2"	7/8" - 14 UNF - 2B	80	40
MRB1600	10 - 13 - 1/2"	1" - 14 UNS - 2B	80	40
MRB1597	12 - 16 - 5/8"	1" - 14 UNS - 2B	80	40
MRB1499	12 - 16 - 5/8"	7/8" - 14 UNF - 2B	75	40

**COMPACT FASTCLIC FITTING 90° ROTALOCK FEMALE OR
WITH LOW PRESSURE VALVE
RACCORDO FASTCLIC 90° COMPATTO ROTALOCK FEMMINA OR
CON VALVOLA BASSA PRESSIONE**

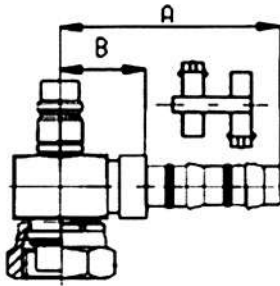

CODICE CODE	TUBO HOSE	FILETTATURA THREADING	A	B	VALVOLA VALVE
	size - dn - inch				
MRB1550	10 - 13 - 1/2"	1" - 14 UNS - 2B	80	40	L.P.
MRB1501	12 - 16 - 5/8"	1" - 14 UNS - 2B	80	40	L.P.

**COMPACT FASTCLIC FITTING 90° ROTALOCK FEMALE OR WITH
HIGH PRESSURE VALVE
RACCORDO FASTCLIC 90° COMPATTO ROTALOCK FEMMINA OR
CON VALVOLA ALTA PRESSIONE**

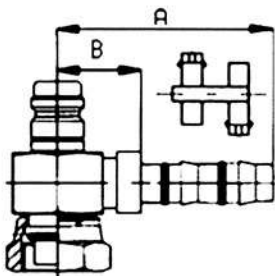

CODICE CODE	TUBO HOSE	FILETTATURA THREADING	A	B	VALVOLA VALVE
	size - dn - inch				
MRB1548	08 - 10 - 13/32"	1" - 14 UNS - 2B	80	40	H.P.

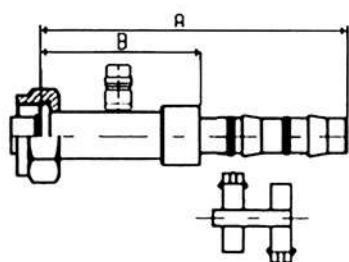

**FASTCLIC FITTING 180° ROTALOCK FEMALE OR WITH VALVE
RACCORDO FASTCLIC 180° ROTALOCK FEMMINA OR CON VALVOLA**

CODICE CODE	TUBO HOSE	FILETTATURA THREADING	A	B	VALVOLA VALVE
	size - dn - inch				
MRB1538	08 - 10 - 13/32"	1"-14 UNS - 2B	95	55	H.P.
MRB1540	10 - 13 - 1/2"	1"-14 UNS - 2B	95	55	L.P.
MRB1472	12 - 16 - 5/8"	1"-14 UNS - 2B	95	55	L.P.

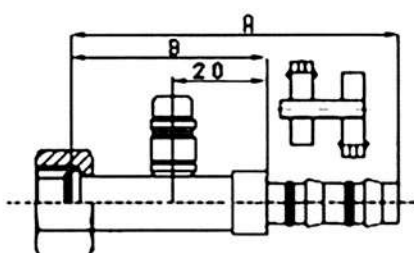

**FASTCLIC FITTING 180° FEMALE OR WITH HIGH PRESSURE VALVE
RACCORDO FASTCLIC 180° FEMMINA OR CON VALVOLA ALTA PRESSIONE**

CODICE CODE	TUBO HOSE	FILETTATURA THREADING	A	B	VALVOLA VALVE
	size - dn - inch				
MRB1401	06 - 8 - 5/16"	5/8" - 18 UNF	95	55	H.P.
MRB1402	08 - 10 - 13/32"	3/4" - 16 UNF	95	55	H.P.
MRB1423	10 - 13 - 1/2"	3/4" - 16 UNF	95	55	H.P.
MRB1424	12 - 16 - 5/8"	7/8" - 14 UNF	95	55	H.P.

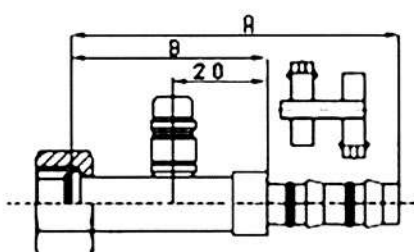

**FASTCLIC FITTING 180° FEMALE OR WITH LOW PRESSURE VALVE
RACCORDO FASTCLIC 180° FEMMINA OR CON VALVOLA LP**

CODICE CODE	TUBO HOSE	FILETTATURA THREADING	A	B	VALVOLA VALVE
	size - dn - inch				
MRB1464	10 - 13 - 1/2"	7/8" - 14 UNF	95	45	L.P.
MRB1466	12 - 16 - 5/8"	7/8" - 14 UNF	95	45	L.P.

FASTCLIC FITTING 45° FEMALE OR WITH VALVE
RACCORDO FASTCLIC 45° FEMMINA OR CON VALVOLA

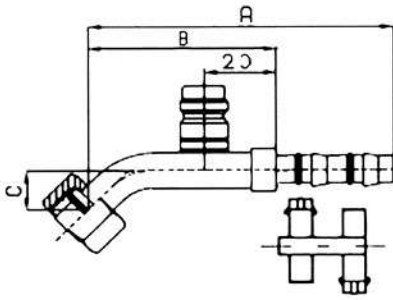

CODICE CODE	TUBO HOSE	FILETTATURA THREADING	A	B	C	VALVOLA VALVE
	size - dn - inch					
MRB1447	08 - 10 - 13/32"	3/4" - 16 UNF	90	50	18	H.P.
MRB1449	10 - 13 - 1/2"	7/8" - 14 UNF	110	70	26	L.P.
MRB1651	12 - 16 - 5/8"	7/8" - 14 UNF	110	70	26	L.P.

FASTCLIC FITTING 90° FEMALE OR WITH HIGH PRESSURE VALVE
RACCORDO FASTCLIC 90° FEMMINA OR CON VALVOLA ALTA PRESSIONE

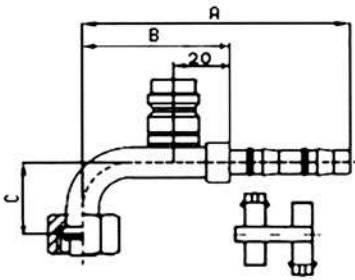

CODICE CODE	TUBO HOSE	FILETTATURA THREADING	A	B	C	VALVOLA VALVE
	size - dn - inch					
MRB1479	06 - 8 - 5/16"	5/8" - 18 UNF	72	32	30	H.P.
MRB1487	08 - 10 - 13/32"	3/4" - 16 UNF	85	45	30	H.P.
MRB1465-HP	10 - 13 - 1/2"	3/4" - 16 UNF	85	45	30	H.P.

FASTCLIC FITTING 90° FEMALE OR WITH LOW PRESSURE VALVE
RACCORDO FASTCLIC 90° FEMMINA OR CON VALVOLA BASSA PRESSIONE

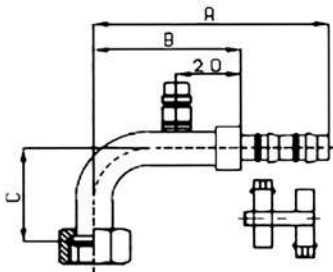

CODICE CODE	TUBO HOSE	FILETTATURA THREADING	A	B	C	VALVOLA VALVE
	size - dn - inch					
MRB1491	10 - 13 - 1/2"	7/8" - 14 UNF	95	55	55	L.P.
MRB1494	12 - 16 - 5/8"	7/8" - 14 UNF	95	55	55	L.P.

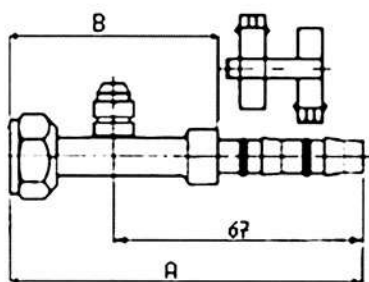

FASTCLIC FITTING 180° FEMALE OR WITH R12 VALVE - 1/4" SAE
RACCORDO FASTCLIC 180° FEMMINA OR CON VALVOLA R12 - 1/4" SAE

CODICE CODE	TUBO HOSE	FILETTATURA THREADING	A	B	VALVOLA VALVE
	size - dn - inch				
MRB1569	06 - 8 - 5/16"	5/8" - 18 UNF	95	55	R12-1/4" SAE
MRB1402	08 - 10 - 13/32"	3/4" - 16 UNF	95	55	R12-1/4" SAE
MRB1474	10 - 13 - 1/2"	7/8" - 14 UNF	95	55	R12-1/4" SAE
MRB1424	12 - 16 - 5/8"	7/8" - 14 UNF	95	55	R12-1/4" SAE

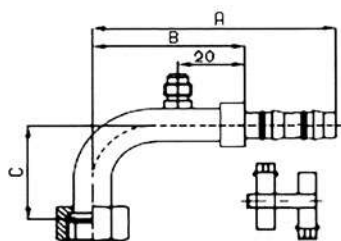

FASTCLIC FITTING 90° FEMALE OR WITH R12 VALVE - 1/4" SAE
RACCORDO FASTCLIC 90° FEMMINA OR CON VALVOLA R12 - 1/4" SAE

CODICE CODE	TUBO HOSE	FILETTATURA THREADING	A	B	C	VALVOLA VALVE
	size - dn - inch					
MRB1407	08 - 10 - 13/32"	3/4" - 16 UNF	80	40	43	R12 - 1/4" SAE
MRB1409	10 - 13 - 1/2"	7/8" - 14 UNF	95	55	55	R12 - 1/4" SAE

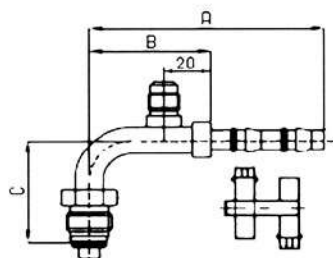

FASTCLIC FITTING 90° MALE OR WITH R12 VALVE - 1/4" SAE
RACCORDO FASTCLIC 90° MASCHIO OR CON VALVOLA R12 - 1/4" SAE

CODICE CODE	TUBO HOSE	FILETTATURA THREADING	A	B	C	VALVOLA VALVE
	size - dn - inch					
MRB1512	06 - 8 - 5/16"	5/8" - 18 UNF	87	47	42	R12 - 1/4" SAE

FASTCLIC FITTING 180° FOR EXPANSION VALVE
RACCORDO FASTCLIC 180° PER VALVOLA DI ESPANSIONE

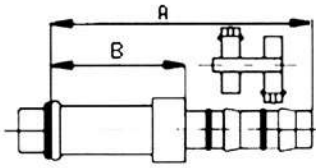

CODICE CODE	TUBO HOSE	A	B
	size - dn - inch		
MRB1566	06 - 8 - 5/16"	85	45
MRB1513	08 - 10 - 13/32"	85	45
MRB1570	10 - 13 - 1/2"	85	45
MRB1514	12 - 16 - 5/8"	85	45

FASTCLIC FITTING 45° FOR EXPANSION VALVE
RACCORDO FASTCLIC 45° PER VALVOLA DI ESPANSIONE

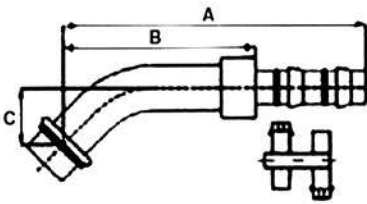

CODICE CODE	TUBO HOSE	A	B	C
	size - dn - inch			
MRB1515	06 - 8 - 5/16"	80	40	14
MRB1517	10 - 13 - 1/2"	117	77	18,5

FASTCLIC FITTING 90° FOR EXPANSION VALVE
RACCORDO FASTCLIC 90° PER VALVOLA DI ESPANSIONE

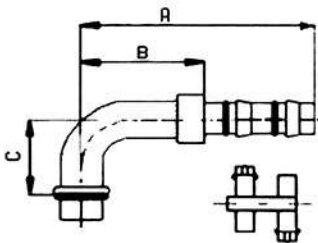

CODICE CODE	TUBO HOSE	A	B	C
	size - dn - inch			
MRB1567	06 - 8 - 5/16"	86	46	46
MRB1571	10 - 13 - 1/2"	94	54	42
MRB1519	12 - 16 - 5/8"	94	54	42

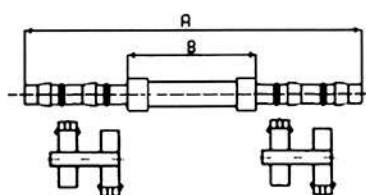

FASTCLIC SPLICER 180°
GIUNZIONE FASTCLIC 180°

CODICE CODE	TUBO HOSE	DIMENSIONS mm	
		A	B
	size - dn - inch		
MRB1526	06 - 8 - 5/16"	125	39
MRB1528	08 - 10 - 13/32"	125	39
MRB1530	10 - 13 - 1/2"	125	39
MRB1532	12 - 16 - 5/8"	125	39

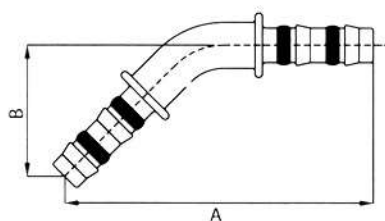

FASTCLIC SPLICER 45°
GIUNZIONE FASTCLIC 45°

CODICE CODE	TUBO HOSE	DIMENSIONS mm	
		A±2.5	B±2.5
	size - dn - inch		
MRB1531	06 8 5/16"	113,5	47,0
MRB1533	08 10 13/32"	121,0	50,0
MRB1534	10 13 1/2"	118,5	49,0

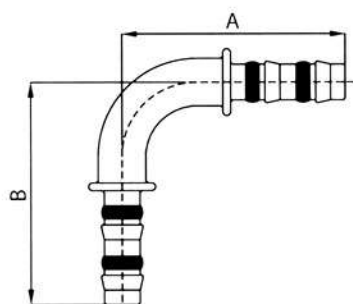

FASTCLIC SPLICER 90°
CONNECTION FITTING 90°

CODICE CODE	TUBO HOSE	DIMENSIONS mm	
		A±2.5	B±2.5
	size - dn - inch		
MRB1539	06 8 5/16"	70,0	70,0
MRB1541	08 10 13/32"	75,0	75,0
MRB1542	10 13 1/2"	75,0	75,0

FASTCLIC SPLICER 180° WITH HIGH PRESSURE VALVE GIUNZIONE FASTCLIC 180° CON VALVOLA ALTA PRESSIONE

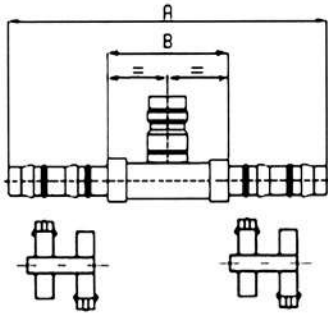

CODICE CODE	TUBO HOSE	A	B	VALVOLA VALVE
	size - dn - inch			
MRB1556	06 - 8 - 5/16"	125	39	H.P.
MRB1558	08 - 10 - 13/32"	125	39	H.P.
MRB1559	10 - 13 - 1/2"	125	39	H.P.
MRB1523	12 - 16 - 5/8"	125	39	H.P.

FASTCLIC SPLICER 180° WITH LOW PRESSURE VALVE GIUNZIONE FASTCLIC 180° CON VALVOLA BASSA PRESSIONE

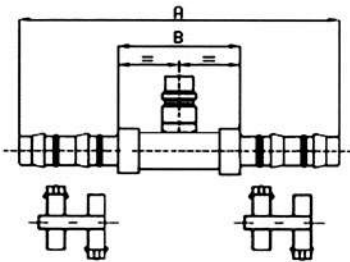

CODICE CODE	TUBO HOSE	A	B	VALVOLA VALVE
	size - dn - inch			
MRB1560	10 - 13 - 1/2"	125	39	L.P.
MRB1562	12 - 16 - 5/8"	125	39	L.P.

3- WAY FASTCLIC SPLICERS GIUNZIONE FASTCLIC 3 VIE - T

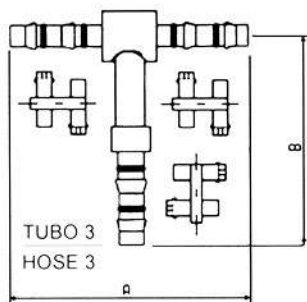

CODICE CODE	TUBO 1 HOSE 1	TUBO 2 HOSE 2	TUBO 3 HOSE 3	A	B
	size - dn - inch	size - dn - inch	size - dn - inch		
MRB1573	06 - 8 - 5/16"	06 - 8 - 5/16"	06 - 8 - 5/16"	125	90
MRB1578	08 - 10 - 13/32"	08 - 10 - 13/32"	08 - 10 - 13/32"	125	90
MRB1583	08 - 10 - 13/32"	08 - 10 - 13/32"	10 - 13 - 1/2"	125	90
MRB1577	10 - 13 - 1/2"	10 - 13 - 1/2"	10 - 13 - 1/2"	125	90
MRB1579	12 - 16 - 5/8"	12 - 16 - 5/8"	12 - 16 - 5/8"	125	90
MRB1580	12 - 16 - 5/8"	12 - 16 - 5/8"	10 - 13 - 1/2"	125	90

3 - WAY FASTCLIC SPLICERS 90°
GIUNZIONE FASTCLIC 3 VIE 90°

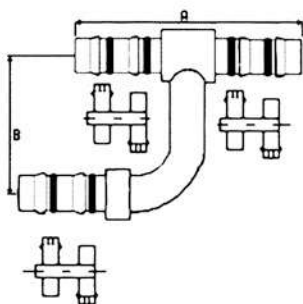

CODICE CODE	TUBO 1 HOSE 1	TUBO 2 HOSE 2	TUBO 3 HOSE 3	A	B
	size - dn - inch	size - dn - inch	size - dn - inch		
MRB1038	06 - 8 - 5/16"	06 - 8 - 5/16"	06 - 8 - 5/16"	125	50
MRB1574	08 - 10 - 13/32"	08 - 10 - 13/32"	08 - 10 - 13/32"	125	45
MRB1039	10 - 13 - 1/2"	10 - 13 - 1/2"	10 - 13 - 1/2"	125	50
MRB1581	12 - 16 - 5/8"	12 - 16 - 5/8"	12 - 16 - 5/8"	138	70

DOUBLE CLAMP FOR FASTCLIC - GHIBLI HOSE
FASCETTA DOPPIA PER FASTCLIC - TUBO GHIBLI

CODICE CODE	TUBO HOSE	Ø EXTERNAL HOSE Ø ESTERNO TUBO
	size - dn - inch	
MRB1586	06 - 8 - 5/16"	16 mm
MRB1588	8 - 10 - 13/32"	18,8 mm
MRB1590	10 - 13 - 1/2"	21,5 mm
MRB1592	12 - 16 - 5/8"	24,1 mm

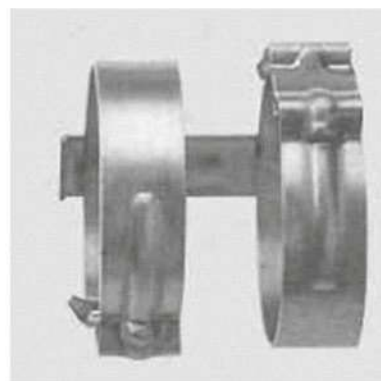

O-RING FOR FASTCLIC COUPLING
O-RING PER RESCA FASTCLIC

CODICE CODE	Ø D2	Ø D1	CARATTERISTICHE
MRB1 - 6 X 1,5	6	1,5	epdm
MRB1 - 8 X 2	8	2	epdm
MRB1 - 10 X 2	10	2	epdm
MRB1 - 13 X 2	13	2	epdm

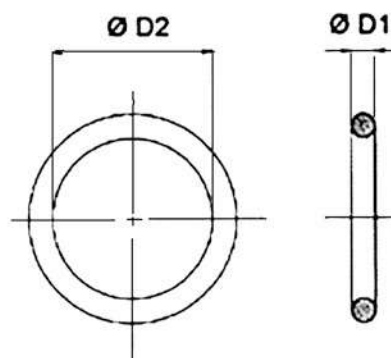

ASSEMBLY
INSTRUCTION
ISTRUZIONI DI
MONTAGGIO
INSTRUCCIONES
DE MONTAJE
Assembling Procedure
GHIBLI / FastClic

1



2



3

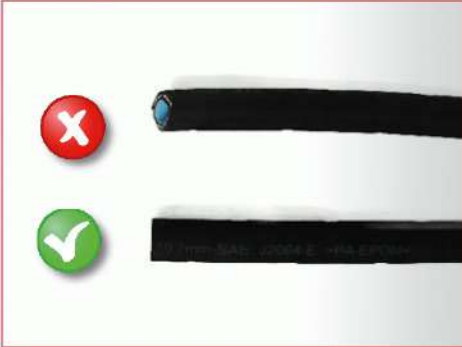

4



5

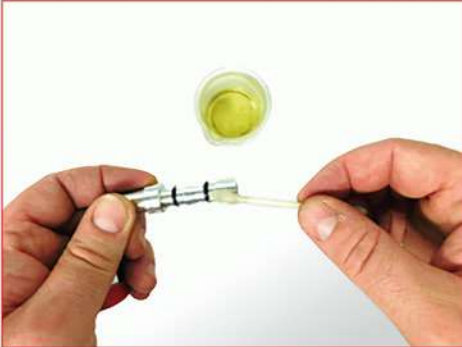

6



7



8



9



5
Slightly lubricate the
Nipple with compressor oil

MAESTRALE MISTRAL



SCM reusable FITTINGS - RACCORDI SCM recuperabili - ACCESORIOS SCM recuperables
Assembly instruction - Istruzioni di montaggio - Instrucciones de montaje

MAESTRALE



Hose Type	MAESTRALE ❄️
Application	AIR CONDITIONING SYSTEMS
Specification (qualifications list is not excluding further specs.)	SAE J2064 Type B
Working Temp.	-40 ÷ 125°C

Peak Temp.	140°C
Tube	IIR Rubber
Reinforcement	1 Steel wire braid
Cover	CSM Rubber
Key	Low Noise Transmission
Characteristics	<ul style="list-style-type: none"> - Low permeability to R134a & R404a - High Flexibility - Couplable with Reusable & Crimped Fittings - Suitable for use with PAG/POE oils

DIMENSIONS AND TOLERANCES

DN [mm] ID OD	Size [inch]	Hose ID [mm]		Hose OD [mm]		Max wall th. difference [mm]
		min	max	min	max	
8,0 x 17,2	5/16	7,6	8,4	16,7	17,7	0,4
10,5 x 19,3	13/32	10,1	10,9	18,8	19,8	0,5
12,7 x 23,4	1/2	12,2	13,2	22,8	24,0	0,5
16,0 x 27,3	5/8	15,5	16,5	26,7	27,9	0,5
22,6 x 31,2	7/8	22,0	23,2	30,5	31,9	0,6
28,0 x 38,0	11/8	27,4	28,6	37,3	38,7	0,7

TECHNICAL CHARACTERISTICS

DN [mm] ID OD	Working pressure [bar]	Burst pressure [bar]	Minimum bend radius [mm]	Weight [g/m]
4,8 x 13,0	35	>200	85	210
8,0 x 17,2	35	>200	85	310
10,5 x 19,3	35	>200	95	350
12,7 x 23,4	35	>200	115	500
16,0 x 27,3	35	>200	135	610
22,6 x 31,2	35	>200	155	620
28,0 x 38,0	35	>150	190	830

MISTRAL



Hose Type	MISTRAL
Application	AIR CONDITIONING SYSTEMS
Specification (qualifications list is not excluding further specs.)	SAE J2064 SAE J3062 Barrier, Wire reinforced (type B/C)
Working Temp.	-40 ÷ 125°C

Peak Temp.	140°C
Tube	EPDM - PA
Reinforcement	1 Steel wire braid
Cover	CSM
Key	Low Noise Transmission
Characteristics	<ul style="list-style-type: none"> - Low Noise Transmission - Ultra Low permeability to Rgas - High Flexibility - Couplable with Reusable & Crimped Fittings - Suitable for use with PAG/POE oils

DIMENSIONS AND TOLERANCES

DN [mm] ID OD	Size [inch]	Hose ID [mm]		Hose OD [mm]		Max wall th. difference [mm]
		min	max	min	max	
22,6 x 31,2	7/8	22,0	23,2	30,5	31,9	0,7
28,0 x 38,0	1 1/8	27,4	28,6	37,3	38,7	0,7

TECHNICAL CHARACTERISTICS

DN (mm) ID OD	Working pressure [bar]	Burst pressure [bar]	Minimum bend radius [mm]	Weight [g/m]
28,0 x 38,0	35	>150	90	870

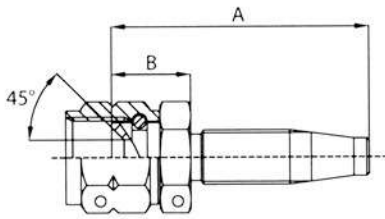
FEMALE 180° - FLARE 45° SAE
FEMMINA 180° - SVASATA 45° SAE

CODICE CODE	TUBO HOSE			FILETTATURA THREADING	DIMENSIONS mm	
	Size	DN	Inch		A±2.5	B±2.5
MRB2004	04	5	3/16"	7/16"-20-UNF-2B	41,0	14,0
MRB2006	06	8	5/16"	5/8"-18-UNF-2B	50,5	15,5
MRB2008	08	10	13/32"	3/4"-16-UNF-2B	59,0	18,0
MRB2009	10	13	1/2"	3/4"-16-UNF-2B	64,0	18,0
MRB2010	12	16	1/2"	7/8"-14-UNF-2B	65,0	19,0
MRB2011	12	16	5/8"	7/8"-14-UNF-2B	68,5	19,0
MRB2012	12	16	5/8"	1.1/16"-14-UNS-2B	78,5	25,5
MRB2013	16	22	7/8"	7/8"-14-UNF-2B	67,5	29,5
MRB2015	16	22	7/8"	1.1/16"-14-UNS-2B	67,5	29,5
MRB2269	16	22	7/8"	1.5/16"-14-UNS-2B	68,0	25,0
MRB2721	20	28	1,1/8"	1.5/8"-12-UNS-2B	92,0	31,0

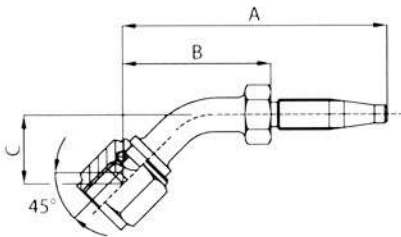
FEMALE 45° - FLARE 45° SAE
FEMMINA 45° - SVASATA 45° SAE

CODICE CODE	TUBO HOSE			FILETTATURA THREADING	DIMENSIONS mm		
	Size	DN	Inch		A±2.5	B±2.5	C±2
MRB2034	04	5	3/16"	7/16"-20-UNF-2B	68,5	41,5	16,0
MRB2036	06	8	5/16"	5/8"-18-UNF-2B	88,0	53,3	16,5
MRB2038	08	10	13/32"	3/4"-16-UNF-2B	94,7	53,7	16,5
MRB2040	10	13	1/2"	7/8"-14-UNF-2B	94,5	48,5	23,5
MRB2041	12	16	5/8"	7/8"-16-UNF-2B	113,0	63,5	26,5
MRB2042	12	16	5/8"	1.1/16"-14-UNS-2B	104,5	55,0	26,5
MRB2043	16	16	5/8"	7/8"-14-UNF-2B	99,5	50,0	23,5
MRB2047	16	22	7/8"	7/8"-14-UNF-2B	97,0	50,0	23,5
MRB2045	16	22	7/8"	1.1/16"-14-UNS-2B	101,5	54,5	26,5

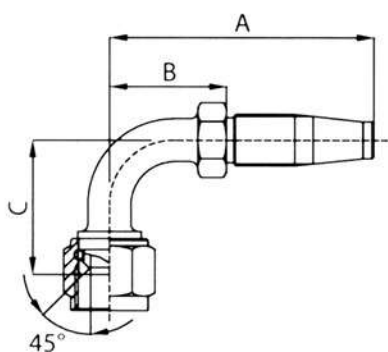

FEMALE 90° - FLARE 45° SAE
FEMMINA 90° - SVASATA 45° SAE

CODICE CODE	TUBO HOSE			FILETTATURA THREADING	DIMENSIONS mm		
	Size	DN	Inch		T	A±2.5	B±2.5
MRB2064	04	5	3/16"	7/16"-20-UNF-2B	55,0	28,0	25,5
MRB2066	06	8	5/16"	5/8"-18-UNF-2B	72,5	37,5	30,5
MRB2068	08	10	13/32"	3/4"-16-UNF-2B	73,5	32,5	37,5
MRB2067	10	13	1/2"	3/4"-16-UNF-2B	73,5	32,5	37,5
MRB2069	12	16	1/2"	3/4"-16-UNF-2B	79,5	33,5	42,5
MRB2070	10	13	1/2"	7/8"-14-UNF-2B	83,5	37,5	46,5
MRB2071	12	16	5/8"	7/8"-14-UNF-2B	84,0	34,5	42,5
MRB2073	16	22	5/8"	7/8"-14-UNF-2B	89,0	39,5	46,5
MRB2072	12	16	5/8"	1.1/16"-14-UNS-2B	94,0	44,5	53,0
MRB2075	16	22	7/8"	1.1/16"-14-UNS-2B	90,5	43,5	53,0
MRB2076	16	22	7/8"	1.5/16"-14-UNS-2B	101,5	54,5	66,5

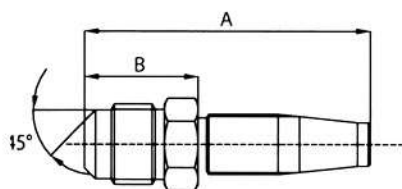

MALE 180° - FLARE 45° SAE
MASCHIO 180° - SVASATO 45° SAE

CODICE CODE	TUBO HOSE			FILETTATURA THREADING	DIMENSIONS mm	
	Size	DN	Inch		T	A±2.5
MRB2304	04	5	3/16"	7/16"-20-UNF-2B	47,5	18,7
MRB2306	06	8	5/16"	5/8"-18-UNF-2B	57,7	22,7
MRB2308	08	10	13/32"	3/4"-16-UNF-2B	68,0	27,0
MRB2310	10	13	1/2"	7/8"-14-UNF-2B	78,4	32,4
MRB2312	12	16	5/8"	1.1/16"-14-UNS-2B	90,4	37,4
MRB2265	16	22	7/8"	1.5/8"-12-UNS-2B	82,0	39,0
MRB2720	20	28	1.1/8"	1.5/16"-14-UNS-2B	84,0	31,0

FEMALE 180° O-RING
FEMMINA 180° O-RING

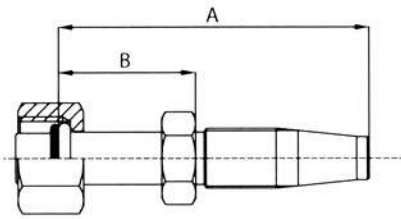

CODICE CODE	TUBO HOSE			FILETTATURA THREADING	DIMENSIONS mm	
	Size	DN	Inch		A±2.5	B±2.5
MRB2266	06	8	5/16"	5/8"-18-UNF-2B	69,0	34,0
MRB2268	08	10	13/32"	3/4"-16-UNF-2B	76,5	35,5
MRB2270	10	13	1/2"	7/8"-14-UNF-2B	96,0	50,0
MRB2271	12	16	5/8"	7/8"-14-UNF-2B	101,5	52,0
MRB2272	12	16	5/8"	1.1/16"-14-UNS-2B	110,0	60,5
MRB2273	16	22	7/8"	1.1/16"-14-UNS-2B	107,5	60,5

FEMALE 45° O-RING
FEMMINA 45° O-RING

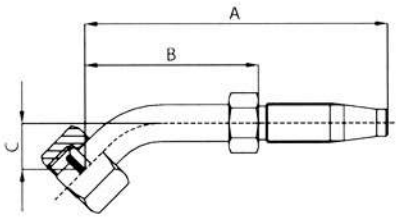

CODICE CODE	TUBO HOSE			FILETTATURA THREADING	DIMENSIONS mm		
	Size	DN	Inch		A±0.10	B±0.10	C±0.08
MRB2286	06	8	5/16"	5/8"-18-UNF-2B	82,0	47,0	12,5
MRB2288	08	10	13/32"	3/4"-16-UNF-2B	90,5	49,5	13,5
MRB2230	10	13	1/2"	7/8"-14-UNF-2B	117,0	71,0	24,0
MRB2289	12	13	1/2"	7/8"-14-UNF-2B	117,0	71,0	24,0
MRB2232	10	13	1/2"	1.1/16"-14-UNS-2B	115,0	69,0	22,0
MRB2287	12	16	5/8"	1 1/16" UNS	122,5	73,0	24,0

FEMALE 90° O-RING
FEMMINA 90° O-RING

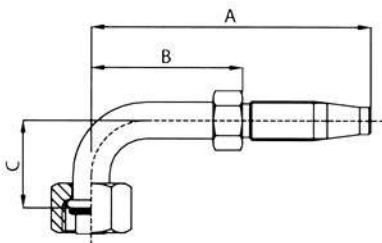

CODICE CODE	TUBO HOSE			FILETTATURA THREADING	DIMENSIONS mm		
	Size	DN	Inch		A±0.10	B±0.10	C±0.08
MRB2276	06	8	5/16"	5/8"-18-UNF-2B	74,0	39,0	24,0
MRB2278	08	10	13/32"	3/4"-16-UNF-2B	81,5	40,5	24,0
MRB2280	10	12	1/2"	7/8"-14-UNF-2B	89,5	48,5	30,0
MRB2281	12	16	5/8"	7/8"-14-UNF-2B	109,5	63,5	45,0
MRB2292	12	16	5/8"	1.1/16"-14-UNS-2B	115,0	65,5	45,0
MRB2285	16	22	7/8"	1.1/16"-14-UNS-2B	119,5	70,0	54,5

FEMALE 90° O-RING W/PORT VALVE
FEMMINA 90° O-RING CON VALVOLA

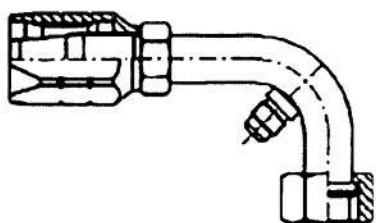

CODICE CODE	TUBO HOSE			FILETTATURA THREADING	VALVOLA VALVE
	Size	DN	Inch		
				T	
MRB2220	10	13	1/2"	7/8"-14 UNF	R12 VALVE 1/4"
MRB2226	16	22	7/8"	1"5/16"-14 UNS	R12 VALVE 1/4"
MRB2170	08	10	13/32"	3/4"-16 UNF	R134 VALVE HP
MRB2021	12	16	5/8"	7/8"-14 UNF	R134 VALVE LP
MRB2016	16	22	7/8"	7/8"-14 UNF	R134 VALVE LP
MRB2020	16	22	7/8"	1"1/16-14 UNS	R134 VALVE LP
MRB2014	20	28	1.1/8"	1"1/16-14 UNS	R134 VALVE LP
MRB2025	10	13	1/2"	3/4"-16 UNF	R12 VALVE 1/4"
MRB2029	12	16	5/8"	3/4"-16 UNF	R12 VALVE 1/4"
MRB2024	16	22	7/8"	7/8"-14 UNF	R12 VALVE 1/4"
MRB2122	12	16	5/8"	1"-14 UNS 2B	R134 VALVE LP
MRB2221	12	16	5/8"	1"-14 UNS 2B	R134 VALVE LP

MALE 180° O-RING
MASCHIO 180° O-RING

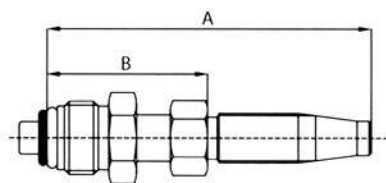

CODICE CODE	TUBO HOSE			FILETTATURA THREADING	DIMENSIONS mm		
	Size	DN	Inch		A±2.5	B±2.5	C±2
				T			
MRB2406	06	8	5/16"	5/8"-18-UNF-2B	69,4	34,4	17
MRB2408	08	10	13/32"	3/4"-18-UNS-2B	85,5	44,5	22
MRB2410	10	13	1/2"	7/8"-18-UNS-2B	94,5	48,5	22

MALE 45° O-RING
MASCHIO 45° O-RING

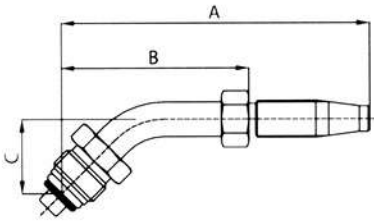

CODICE CODE	TUBO HOSE			FILETTATURA THREADING	DIMENSIONS mm		
	Size	DN	Inch		A±2.5	B±2.5	
MRB2416	06	8	5/16"	5/8"-18-UNF-2B	69,4	34,4	17
MRB2418	08	10	13/32"	3/4"-18-UNS-2B	85,5	44,5	22
MRB2420	10	13	1/2"	7/8"-18-UNS-2B	94,5	48,5	22

MALE 90° O-RING
MASCHIO 90° O-RING

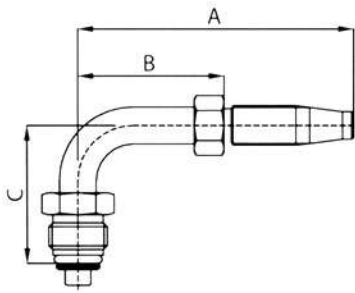

CODICE CODE	TUBO HOSE			FILETTATURA THREADING	DIMENSIONS mm		
	Size	DN	Inch		A±2.5	B±2.5	AB
MRB2426	06	8	5/16"	5/8"-18-UNF-2B	89,5	54,5	21,5
MRB2428	08	10	13/32"	3/4"-18-UNS-2B	106,5	65,5	25,0
MRB2430	10	13	1/2"	7/8"-18-UNS-2B	121,5	75,5	28,5

FEMALE 180° O-RING 24° DIN
FEMMINA 180° O-RING 24° DIN

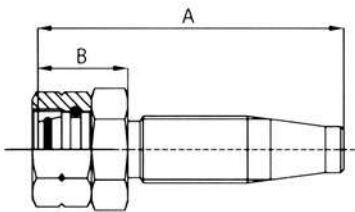

CODICE CODE	TUBO HOSE			FILETTATURA THREADING	DIMENSIONS mm		
	Size	DN	Inch		A±2.5	B±2.5	C±2
MRB2022	12	16	5/8"	M 26x1.5	92,0	42,5	32
MRB2023	10	16	5/8"	M 26x1.5	94,5	45,0	36
MRB2026	16	22	7/8"	M 30x2	74,0	27,0	36
MRB2027	20	28	1.1/8"	M 36x2	76,8	30,8	41

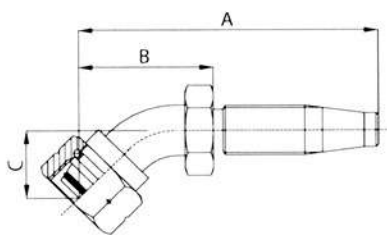

FEMALE 45° O-RING 24° DIN
FEMMINA 45° O-RING 24° DIN

CODICE CODE	TUBO HOSE			FILETTATURA THREADING	DIMENSIONS mm		
	Size	DN	Inch		A±2.5	B±2.5	C±2
MRB2052	12	16	5/8"	M 26x1.5	107,0	57,2	28,7
MRB2056	12	16	5/8"	M 30x2	107,0	57,5	29,0
MRB2057	16	22	7/8"	M 30x2	104,0	57,1	29,4
MRB2059	20	28	1/8"	M 36x2	117,0	69,9	30,0
MRB2058	16	22	7/8"	M 36x2	115,0	68,9	34,0
MRB2061	20	28	1/8"	M 36x2	117,0	69,9	30,0

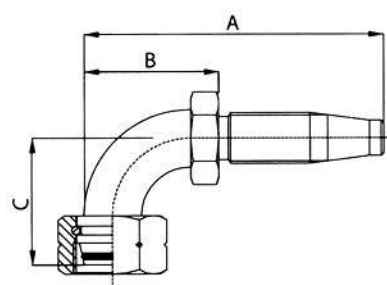

FEMALE 90° O-RING 24° DIN
FEMMINA 90° O-RING 24° DIN

CODICE CODE	TUBO HOSE			FILETTATURA THREADING	DIMENSIONS mm		
	Size	DN	Inch		A±2.5	B±2.5	C±2
MRB2082	12	16	5/8"	M 26x1.5	94,0	44,5	56,0
MRB2086	16	22	7/8"	M 30x2	91,0	43,5	56,5
MRB2088	20	28	1.1/8"	M 36x2	101,0	54,5	69,3

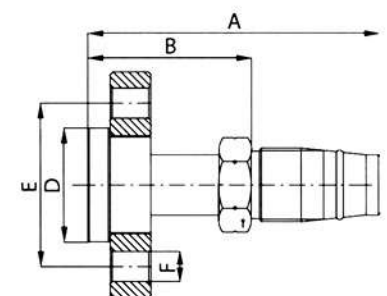

180° FLANGE FITTING
RACCORDO 180° CON FLANGIA

CODICE CODE	TUBO HOSE			FILETTATURA THREADING	DIMENSIONS mm		
	Size	DN	Inch		A±2.5	B±2.5	C±2
MRB2090	16	22	7/8"	5/8"-18-UNF-2B	107,0	60,0	41,8
MRB2091	20	28	1.1/8"	3/4"-18-UNS-2B	110,5	64,5	41,8

45° FLANGE FITTING
RACCORDO 45° CON FLANGIA

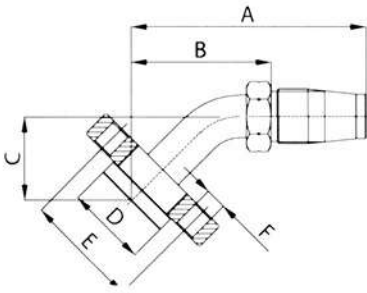

CODICE CODE	TUBO HOSE			DIMENSIONS mm					
	Size	DN	Inch	A±2.5	B±2.5	C±2	D	E	F
MRB2092	16	22	7/8"	119,0	72,0	44,0	41,8	60,0	∅ 11,0
MRB2093	20	28	1.1/8"	122,5	76,5	44,0	41,8	60,0	∅ 11,0

90° FLANGE FITTING
RACCORDO 90° CON FLANGIA

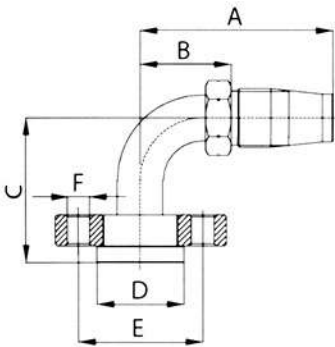

CODICE CODE	TUBO HOSE			DIMENSIONS mm					
	Size	DN	Inch	A±2.5	B±2.5	C±2	D	E	F
MRB2094	16	22	7/8"	90,5	43,5	79,5	41,8	60,0	∅ 11,0
MRB2095	20	28	1.1/8"	100,5	54,5	88,5	41,8	60,0	∅ 11,0

ORS FLAT SEAL FEMALE 180°
FEMMINA TENUTA FRONTALE ORS 180°

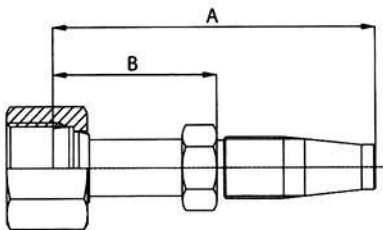

CODICE CODE	TUBO HOSE			FILETTATURA THREADING	DIMENSIONS mm	
	Size	DN	Inch		A±2.5	B±2.5
MRB2154	04	5	3/16"	9/16"-18-UNF-2B	61,0	34,0
MRB2156	06	8	5/16"	11/16"-UN-2B	69,0	34,0
MRB2158	08	10	13/32"	13/16"-16-UN-2B	78,0	37,0
MRB2180	10	13	1/2"	1"-14-UNS-2B	93,5	47,5
MRB2182	12	16	5/8"	1.3/16"-12-UN-2B	99,0	49,5
MRB2031	12	16	5/8"	1"7/16"-12-UNF-2B	52,5	102,0
MRB2186	12	16	5/8"	1"7/16"-12-UNF-2B	29,0	78,5
MRB2033	16	22	7/8"	1"1/16"-UN-2B	69,5	116,5
MRB2190	20	28	1.1/8"	1"11/16"-12-UN-2B	114,5	68,5

ORS FLAT SEAL FEMALE 45°
FEMMINA TENUTA FRONTALE ORS 45°

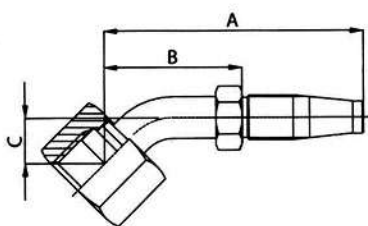

CODICE CODE	TUBO HOSE			FILETTATURA THREADING	DIMENSIONS mm		
	Size	DN	Inch		T	A±2.5	B±2.5
MRB2134	04	5	3/16"	9/16"-18 - UNF-2B	52,2	25,2	10,0
MRB2136	05	8	5/16"	11/16"-16 - UN-2B	62,3	27,3	10,5
MRB2138	08	10	13/32"	13/16"-16 - UN-2B	96,5	55,5	13,0
MRB2140	10	13	1/2"	1"-14 - UNS -2B	86,5	40,5	16,0
MRB2142	12	16	5/8"	1"3/16"-12 - UN-2B	115,0	65,5	17,0
MRB2018	16	22	7/8"	1"7/16"-12 - UN-2B	115,5	68,5	40,5
MRB2005	20	28	1.1/8"	1"11/16"-12 - U N-2B	111,5	66,5	27,0
MRB2019	24	35	1.3/8"	1"11/16"-12 - U N-2B	115,5	70,5	29,0

ORS FLAT SEAL FEMALE 90°
FEMMINA TENUTA FRONTALE ORS - 90°

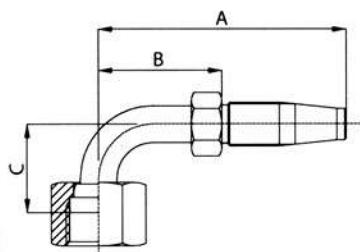

CODICE CODE	TUBO HOSE			FILETTATURA THREADING	DIMENSIONS mm		
	Size	DN	Inch		T	A±2.5	B±2.5
MRB2144	04	5	3/16"	9/16"-18-UNF-2B	50,5	23,5	22,5
MRB2146	06	8	5/16"	11/16"-16-UN-2B	62,5	27,5	25,5
MRB2148	08	10	13/32"	13/16"-16-UN-2B	81,5	40,5	29,0
MRB2150	10	13	1/2"	1" - 14-UNS-2B	83,5	37,5	36,0
MRB2152	12	16	5/8"	1"3/16"-12-UN-2B	98,0	48,5	45,0
MRB2030	12	16	5/8"	1"7/16"-12-UN-2B			
MRB2017	16	22	7/8"	1"7/16"-12-UN-2B	104,5	58,5	56,0
MRB2032	16	22	7/8"	1"11/16"-12-UN-2B			
MRB2130	20	28	1"1/8"	1"11/16"-12-UN-2B	104,5	58,5	56,0

**JIC 37° STRAIGHT FEMALE FITTING
FEMMINA JIC 37° - DRITTO**

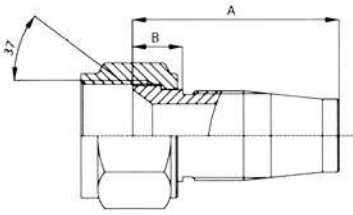

CODICE CODE	TUBO HOSE			FILETTATURA THREADING	DIMENSIONS mm	
	Size	DN	Inch		A±2.5	B±2.5
MRB2028	16	22	7/8"	1"5/8"-12-UNF-2B		
MRB2265	16	22	7/8"	1"5/16"-12-UNF-2B	62,0	15,0

**STRAIGHT CONNECTION FITTING
GIUNZIONE DRITTA**

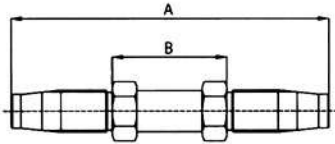

CODICE CODE	TUBO HOSE				DIMENSIONS mm	
	Size	DN	Inch		A±2.5	B±2.5
MRB2234	04	5	3/16"		89,0	35,0
MRB2236	06	8	5/16"		115,0	45,0
MRB2238	08	10	13/32"		128,0	46,0
MRB2240	10	13	1/2"		141,0	49,0
MRB2242	12	16	5/8"		154,5	55,5
MRB2246	16	22	7/8"		145,0	51,0
MRB2250	20	28	1.1/8"		163,0	71,0

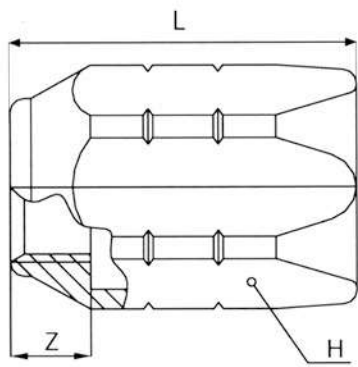

REUSABLE FERRULE BOCCOLE RECUPERABILI

CODICE CODE	TUBO HOSE			DIMENSIONS mm		
	Size	DN	Inch	Z	H	l
MRB2104	04	5	3/16"	8	17	28
MRB2106	06	8	5/16"	10	22	33
MRB2108	08	10	13/32"	13	24	43
MRB2110	10	12	1/2"	13	30	45
MRB2112	12	16	5/8"	13	32	53
MRB2116	16	22	7/8"	11	36	43
MRB2120	20	28	1"1/8"	10	46	43

ASSEMBLY
INSTRUCTION
ISTRUZIONI DI
MONTAGGIO
INSTRUCCIONES
DE MONTAJE

Assembling Procedure
MAESTRALE / SCM

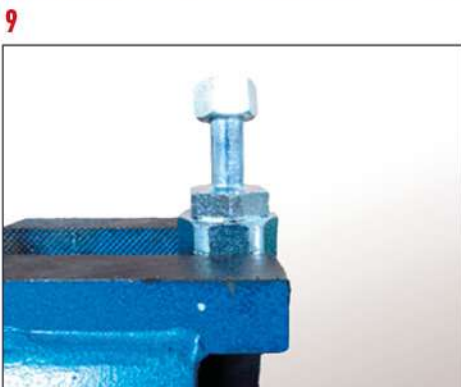

2
Cut the hose with metal
disk (not abrasive disc).

3
Clean the hose carefully
from any cutting residue.

5/6
Make sure to screw the
socket to the end

7
Lubricate the Nipple with
compressor oil

8
Make sure to screw
the nipple to the end,
without any unscrewing

GLACIER ICEBERG BLIZZARD

CRIMPING FITTINGS - RACCORDI A CRIMPARE - RACORES PARA ENGASTAR



GLACIER



Hose Type	GLACIER
Application	AIR CONDITIONING SYSTEMS
Specification (qualifications list is not excluding further specs.)	SAE J2064 TYPE A; FIAT 9.93460/01
Working Temp.	- 40 ÷ 125°C

Peak Temp.	140°C
Tube	IIR compound
Reinforcement	2 textile spirals
Cover	EPDM compound
Key characteristics	<ul style="list-style-type: none"> - Low noise and vibration transmission - Low permeability to HFC 134a - High flexibility

DIMENSIONS AND TOLERANCES

DN [mm] ID OD	Size [inch]	Hose ID [mm]		Hose OD [mm]		Max wall th. difference [mm]
		min	max	min	max	
8,0 x 18,2	5/16	7,7	8,3	17,7	18,7	0,4
10,5 x 22,0	13/32	10,2	10,8	21,7	22,7	0,4
12,7 x 24,4	1/2	12,4	13,0	24,1	25,1	0,6
16,0 x 27,0	5/8	15,6	16,5	26,4	27,6	0,6
19,4 x 31,7	3/4	18,9	19,9	31,1	32,3	0,6

TECHNICAL CHARACTERISTICS

DN [mm] ID OD	Working pressure [bar]	Actual Burst pressure [bar]	Minimum bend radius [mm]	Weight [g/m]
8,0 x 18,2	35	>160	60	260
10,5 x 22,0	35	>160	80	360
12,7 x 24,4	35	>160	95	410
16,0 x 27,0	35	>160	120	450
19,4 x 31,7	35	>100	130	540

ICEBERG



Hose Type	ICEBERG
Application	AIR CONDITIONING SYSTEMS
Specification (qualifications list is not excluding further specs.)	SAE J2064 type C
Working Temp.	- 40 ÷ 125°C

Peak Temp.	140°C
Tube	EPDM-PA
Reinforcement	1 textile braid
Cover	EPDM

Key characteristics

- Low Permeability to Refrigerant Fluids;
- Compatibility with a wide range of refrigerants such as R134a, R1234yf, R404a;
- Very Low Moisture Ingression
- Very High Flexibility;
- Low Noise Transmission

DIMENSIONS AND TOLERANCES

DN [mm] ID OD	Size [inch]	Hose ID [mm]		Hose OD [mm]		Max wall th. difference [mm]
		min	max	min	max	
8,3 x 19,0	5/16	7,9	8,6	18,5	19,5	0,6
10,8 x 23,0	13/32	10,4	11,2	22,5	23,5	0,7
12,7 x 25,4	1/2	12,3	13,1	24,9	25,9	0,7
16,1 x 28,6	5/8	15,6	16,6	28,1	29,1	0,7

TECHNICAL CHARACTERISTICS

DN (mm) ID OD	Working pressure [bar]	Actual Burst pressure [bar]	Minimum bend radius [mm]	Weight
				[g/m]
8,3 x 19,0	35	>140	40	310
10,8 x 23,0	35	>140	50	440
12,7 x 25,4	35	>140	60	510
16,1 x 28,6	20	>120	70	590

BLIZZARD



Hose Type	BLIZZARD
Application	AIR CONDITIONING SYSTEMS
Specification (qualifications list is not excluding further specs.)	TI H42; SAE J2064 type C Barrier; RENAULT 32-02-017;
Working Temp.	- 40 ÷ 125°C

Peak Temp.	150°C
Tube	EPDM-PA
Reinforcement	1 textile braid
Cover	EPDM

- Key characteristics
- Reduced External Outer Diameter
 - Low Permeability to Refrigerant Fluids;
 - Compatibility with a wide range of refrigerants such as R134a, R1234yf, R404a;
 - Very High Flexibility;
 - Low Noise Transmission

DIMENSIONS AND TOLERANCES

DN [mm] ID OD	Size [inch]	Hose ID [mm]		Hose OD [mm]		Max wall th. difference [mm]
		min	max	min	max	
8,3 x 14,7	5/16	7,9	8,6	14,2	15,2	0,6
10,8 x 17,3	13/32	10,4	11,2	16,8	17,8	0,7
12,7 x 19,4	1/2	12,3	13,1	18,9	19,9	0,7
16,1 x 23,6	5/8	15,6	16,6	23,1	24,1	0,7

TECHNICAL CHARACTERISTICS

DN (mm) ID OD	Working pressure [bar]	Actual Burst pressure [bar]	Minimum bend radius [mm]	Weight [g/m]
8,3 x 14,7	35	>200	40	130
10,8 x 17,3	35	>200	50	160
12,7 x 19,4	35	>200	60	190
16,1 x 23,6	25	>150	70	260

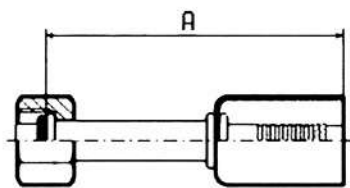

FITTINGS FOR STANDARD HOSE
RACCORDI CON CAMPANA
SEZIONE STANDARD

**CRIMP FITTING 180° FEMALE OR
RACCORDO DRITTO FEMMINA OR**

CODICE CODE	TUBO HOSE	FILETTATURA THREADING	A
	size - dn - inch		
MRB3606	06 - 8 - 5/16"	5/8"-18 UNF	66
MRB3613	08 - 10 -13/32"	5/8"-18 UNF	70
MRB3608	08 - 10 -13/32"	3/4"-16 UNF	70
MRB3610	10 - 13 - 1/2"	7/8"-14 UNF	77
MRB3612	12 - 16 - 5/8"	7/8"-14 UNF	77
MRB3614	12 - 16 - 5/8"	1"1/16"-14 UNS	77

FITTINGS FOR COMPACT HOSE
RACCORDI CON CAMPANA
SEZIONE RIDOTTA

MRB3606-R	06 - 8 - 5/16"	5/8"-18 UNF	66
MRB3613-R	08 - 10 -13/32"	5/8"-18 UNF	70
MRB3608-R	08 - 10 -13/32"	3/4"-16 UNF	70
MRB3610-R	10 - 13 - 1/2"	7/8"-14 UNF	77
MRB3612-R	12 - 16 - 5/8"	7/8"-14 UNF	77
MRB3614-R	12 - 16 - 5/8"	1"1/16"-14 UNS	77

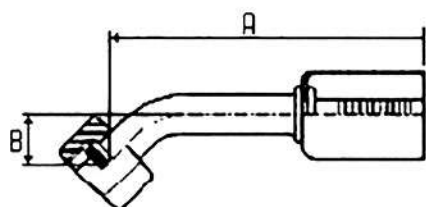

FITTINGS FOR STANDARD HOSE
RACCORDI CON CAMPANA
SEZIONE STANDARD

**CRIMP FITTING 45° FEMALE OR
RACCORDO 45° FEMMINA OR**

CODICE CODE	TUBO HOSE	FILETTATURA THREADING	A	B
	size - dn - inch			
MRB3616	06 - 8 - 5/16"	5/8"-18 UNF	80	12,5
MRB3618	08 - 10 -13/32"	3/4"-16 UNF	88	13,5
MRB3620	10 - 13 - 1/2"	7/8"-14 UNF	99	24
MRB3617	12 - 16 - 5/8"	7/8"-14 UNF	99	24
MRB3622	12 - 16 - 5/8"	1"1/16-14 UNS	99	24

FITTINGS FOR COMPACT HOSE
RACCORDI CON CAMPANA
SEZIONE RIDOTTA

MRB3616-R	06 - 8 - 5/16"	5/8"-18 UNF	80	12,5
MRB3618-R	08 - 10 -13/32"	3/4"-16 UNF	88	13,5
MRB3620-R	10 - 13 - 1/2"	7/8"-14 UNF	99	24
MRB3617-R	12 - 16 - 5/8"	7/8"-14 UNF	99	24
MRB3622-R	12 - 16 - 5/8"	1"1/16-14 UNS	99	24

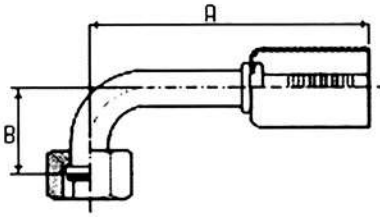

FITTINGS FOR STANDARD HOSE
RACCORDI CON CAMPANA
SEZIONE STANDARD

**CRIMP FITTING 90° FEMALE OR
RACCORDO 90° FEMMINA OR**

CODICE CODE	TUBO HOSE	FILETTATURA THREADING	A	B
	size - dn - inch			
MRB3626	06 - 8 - 5/16"	5/8" - 18 UNF	72	28
MRB3628	08 - 10 - 13/32"	3/4" - 16 UNF	79	34
MRB3630	10 - 13 - 1/2"	7/8" - 14 UNF	92	47
MRB3632	12 - 16 - 5/8"	7/8" - 14 UNF	92	47
MRB3634	12 - 16 - 5/8"	1" 1/16 - 14 UNS	92	47

FITTINGS FOR COMPACT HOSE
RACCORDI CON CAMPANA
SEZIONE RIDOTTA

MRB3626-R	06 - 8 - 5/16"	5/8" - 18 UNF	72	28
MRB3628-R	08 - 10 - 13/32"	3/4" - 16 UNF	79	34
MRB3630-R	10 - 13 - 1/2"	7/8" - 14 UNF	92	47
MRB3632-R	12 - 16 - 5/8"	7/8" - 14 UNF	92	47
MRB3634-R	12 - 16 - 5/8"	1" 1/16" - 14 UNS	92	47

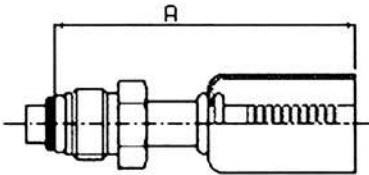

FITTINGS FOR STANDARD HOSE
RACCORDI CON CAMPANA
SEZIONE STANDARD

**CRIMP FITTING 180° MALE OR
RACCORDO DRITTO MASCHIO OR**

CODICE CODE	TUBO HOSE	FILETTATURA THREADING	A
	size - dn - inch		
MRB3666	06 - 8 - 5/16"	5/8" - 18 UNF	70
MRB3668	08 - 10 - 13/32"	3/4" - 18 UNS	79
MRB3670	10 - 13 - 1/2"	7/8" - 18 UNS	79
MRB3672	12 - 16 - 5/8"	7/8" - 18 UNS	79

FITTINGS FOR COMPACT HOSE
RACCORDI CON CAMPANA
SEZIONE RIDOTTA

MRB3666-R	06 - 8 - 5/16"	5/8" - 18 UNF	70
MRB3671-R	08 - 10 - 13/32"	5/8" - 18 UNF	79
MRB3668-R	08 - 10 - 13/32"	3/4" - 18 UNS	79
MRB3670-R	10 - 13 - 1/2"	7/8" - 18 UNS	79
MRB3672-R	12 - 16 - 5/8"	7/8" - 18 UNS	79

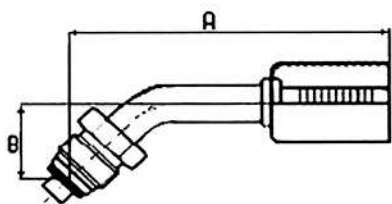

**CRIMP FITTING 45° MALE OR
RACCORDO 45° MASCHIO OR**

FITTINGS FOR STANDARD HOSE
RACCORDI CON CAMPANA
SEZIONE STANDARD

CODICE CODE	TUBO HOSE	FILETTATURA THREADING	A	B
	size - dn - inch			
MRB3676	06 - 8 - 5/16"	5/8"-18 UNF	83	21,5
MRB3678	08 - 10 - 13/32"	3/4"-18 UNS	96	31
MRB3680	10 - 13 - 1/2"	7/8"-18 UNS	106	31

FITTINGS FOR COMPACT HOSE
RACCORDI CON CAMPANA
SEZIONE RIDOTTA

MRB3676-R	06 - 8 - 5/16"	5/8"-18 UNF	83	21,5
MRB3678-R	08 - 10 - 13/32"	3/4"-18 UNS	96	31
MRB3680-R	10 - 13 - 1/2"	7/8"-18 UNS	106	31

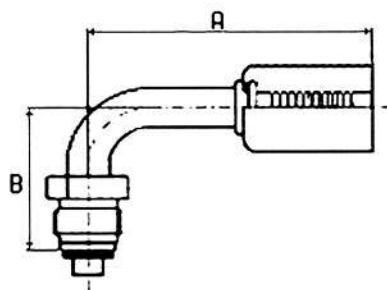

**CRIMP FITTING 90° MALE OR
RACCORDO 90° MASTCHIO OR**

FITTINGS FOR STANDARD HOSE
RACCORDI CON CAMPANA
SEZIONE STANDARD

CODICE CODE	TUBO HOSE	FILETTATURA THREADING	A	B
	size - dn - inch			
MRB3686	06 - 8 - 5/16"	5/8"-18 UNF	68	41
MRB3688	08 - 10 - 13/32"	3/4"-18 UNS	84	48
MRB3690	10 - 13 - 1/2"	7/8"-18 UNS	87	54,5

FITTINGS FOR COMPACT HOSE
RACCORDI CON CAMPANA
SEZIONE RIDOTTA

MRB3686-R	06 - 8 - 5/16"	5/8"-18 UNF	68	41
MRB3688-R	08 - 10 - 13/32"	3/4"-18 UNS	84	48
MRB3690-R	10 - 13 - 1/2"	7/8"-18 UNS	87	54,5

CRIMP FITTING 180° FEMALE FLARE 45°
ACCORDO DRITTO SVASATO 45°

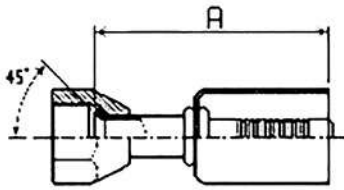

CODICE CODE	TUBO HOSE	FILETTATURA THREADING	A
	size - dn - inch		
MRB3846	06 - 8 - 5/16"	5/8" - 18 UNF	55
MRB3848	08 - 10 - 13/32"	3/4" - 16 UNF	90
MRB3850	10 - 13 - 1/2"	7/8" - 14 UNF	65

CRIMP FITTING 45° FEMALE FLARE 45°
RACCORDO CURVA 45° SVASATO 45°

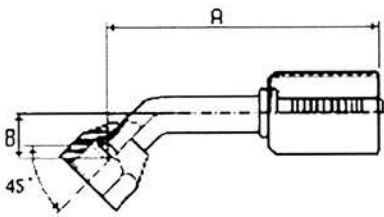

CODICE CODE	TUBO HOSE	FILETTATURA THREADING	A	B
	size - dn - inch			
MRB3816	06 - 8 - 5/16"	5/8" - 18 UNF	75	10
MRB3818	08 - 10 - 13/32"	3/4" - 16 UNF	85	13
MRB3820	10 - 13 - 1/2"	7/8" - 14 UNF	110	17

CRIMP FITTING 90° FEMALE FLARE 45°
RACCORDO CURVA 90° SVASATO 45°

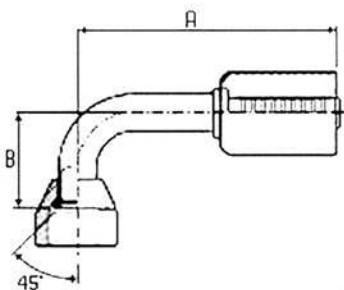

CODICE CODE	TUBO HOSE	FILETTATURA THREADING	A	B
	size - dn - inch			
MRB3826	06 - 8 - 5/16"	5/8" - 18 UNF	80	27
MRB3828	08 - 10 - 13/32"	3/4" - 16 UNF	85	35
MRB3830	10 - 13 - 1/2"	7/8" - 14 UNF	100	45

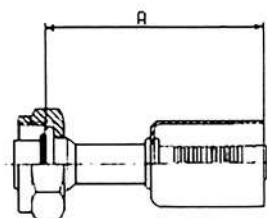

FITTINGS FOR STANDARD HOSE
RACCORDI CON CAMPANA
SEZIONE STANDARD

**CRIMP FITTING 180° FEMALE OR ROTALOCK
RACCORDO DRITTO FEMMINA ROTALOCK**

CODICE CODE	TUBO HOSE	FILETTATURA THREADING	A
	size - dn - inch		
MRB3638	08 - 10 - 13/32"	1"-14 UNS-2B	66
MRB3640	10 - 13 - 1/2"	1"-14 UNS-2B	70
MRB3642	12 - 16 - 5/8"	1"-14 UNS-2B	70

FITTINGS FOR COMPACT HOSE
RACCORDI CON CAMPANA
SEZIONE RIDOTTA

MRB3638-R	08 - 10 - 13/32"	1"-14 UNS-2B	66
MRB3640-R	10 - 13 - 1/2"	1"-14 UNS-2B	57
MRB3642-R	12 - 16 - 5/8"	1"-14 UNS-2B	57

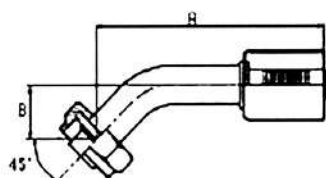

FITTINGS FOR STANDARD HOSE
RACCORDI CON CAMPANA
SEZIONE STANDARD

**CRIMP FITTING 45° FEMALE OR ROTALOCK
RACCORDO 45° FEMMINA ROTALOCK**

CODICE CODE	TUBO HOSE	FILETTATURA THREADING	A	B
	size - dn - inch			
MRB3648	08 - 10 - 13/32"	1"-14 UNS-2B	85	14
MRB3650	10 - 13 - 1/2"	1"-14 UNS-2B	98	22
MRB3652	12 - 16 - 5/8"	1"-14 UNS-2B	98	22

FITTINGS FOR COMPACT HOSE
RACCORDI CON CAMPANA
SEZIONE RIDOTTA

MRB3648-R	08 - 10 - 13/32"	1"-14 UNS-2B	85	14
MRB3650-R	10 - 13 - 1/2"	1"-14 UNS-2B	98	22
MRB3652-R	12 - 16 - 5/8"	1"-14 UNS-2B	98	22

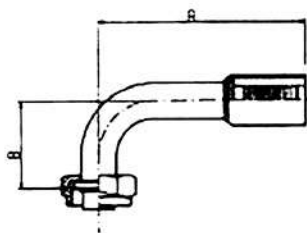

FITTINGS FOR STANDARD HOSE
RACCORDI CON CAMPANA
SEZIONE STANDARD

**CRIMP FITTING 90° FEMALE OR ROTALOCK
RACCORDO 90° FEMMINA ROTALOCK**

CODICE CODE	TUBO HOSE	FILETTATURA THREADING	A	B
	size - dn - inch			
MRB3658	08 - 10 - 13/32"	1"-14 UNS-2B	78	33
MRB3660	10 - 13 - 1/2"	1"-14 UNS-2B	93	39
MRB3662	12 - 16 - 5/8"	1"-14 UNS-2B	93	39

FITTINGS FOR COMPACT HOSE
RACCORDI CON CAMPANA
SEZIONE RIDOTTA

MRB3658-R	08 - 10 - 13/32"	1"-14 UNS-2B	78	33
MRB3660-R	10 - 13 - 1/2"	1"-14 UNS-2B	93	39
MRB3662-R	12 - 16 - 5/8"	1"-14 UNS-2B	93	39

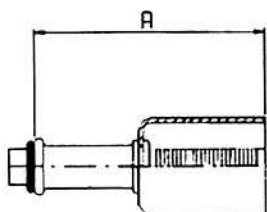

FITTINGS FOR STANDARD HOSE
RACCORDI CON CAMPANA
SEZIONE STANDARD

**CRIMP FITTING 180° FEMALE OR FOR EXPANSION VALVE
RACCORDO FEMMINA PER VALVOLA ESPANSIONE**

CODICE CODE	TUBO HOSE	FILETTATURA THREADING	A
	size - dn - inch		
MRB3726	06 - 8 - 5/16"	5/16"	56
MRB3730	10 - 13 - 1/2"	1/2"	68

FITTINGS FOR COMPACT HOSE
RACCORDI CON CAMPANA
SEZIONE RIDOTTA

MRB3726-R	06 - 8 - 5/16"	5/16"	56
MRB3730-R	10 - 13 - 1/2"	1/2"	68

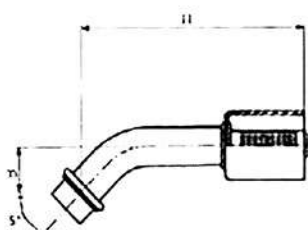

FITTINGS FOR STANDARD HOSE
RACCORDI CON CAMPANA
SEZIONE STANDARD

**CRIMP FITTING 45° FEMALE OR FOR EXPANSION VALVE
RACCORDO FEMMINA A 45° PER VALV. ESPANSIONE**

CODICE CODE	TUBO HOSE	FILETTATURA THREADING	A	B
	size - dn - inch			
MRB3736	06 - 8 - 5/16"	5/16"	80	14
MRB3740	10 - 13 - 1/2"	1/2"	97	19
MRB3742	12 - 16 - 5/8"	1/2"	97	19

FITTINGS FOR COMPACT HOSE
RACCORDI CON CAMPANA
SEZIONE RIDOTTA

MRB3736-R	06 - 8 - 5/16"	5/16"	80	14
MRB3740-R	10 - 13 - 1/2"	1/2"	97	19
MRB3742-R	12 - 16 - 5/8"	1/2"	97	19
MRB3617-R	12 - 16 - 5/8"	7/8"-14 UNF	99	24
MRB3622-R	12 - 16 - 5/8"	1"1/16-14 UNS	99	24

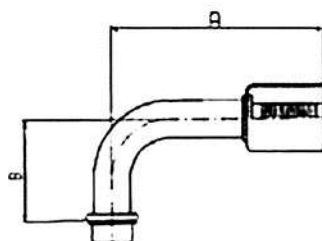

FITTINGS FOR STANDARD HOSE
RACCORDI CON CAMPANA
SEZIONE STANDARD

**CRIMP FITTING 90° FEMALE OR FOR EXPANSION VALVE
RACCORDO FEMMINA 90° PER VALV. ESPANSIONE**

CODICE CODE	TUBO HOSE	FILETTATURA THREADING	A	B
	size - dn - inch			
MRB3746	06 - 8 - 5/16"	5/16"	86	24
MRB3750	10 - 13 - 1/2"	1/2"	95	43

FITTINGS FOR COMPACT HOSE
RACCORDI CON CAMPANA
SEZIONE RIDOTTA

MRB3746-R	06 - 8 - 5/16"	5/16"	86	24
MRB3750-R	10 - 13 - 1/2"	1/2"	95	43

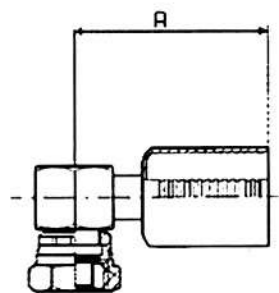

FITTINGS FOR STANDARD HOSE
RACCORDI CON CAMPANA
SEZIONE STANDARD

**CRIMP FITTING 90° ROTALOCK
RACCORDO BLOCCHETTO A 90°**

CODICE CODE	TUBO HOSE	FILETTATURA THREADING	A	CH
	size - dn - inch			
MRB3706	06 - 8 - 5/16"	5/8" -18- UNF	47	19
MRB3708	08 - 10 -13/32"	3/4" -16- UNF	52	22
MRB3718	08 - 10 -13/32"	1" -14 UNS -2B	55	29
MRB3710	10 - 13 - 1/2"	7/8" -14 UNF	55	27
MRB3720	10 - 13 - 1/2"	1" -14 UNS -2B	55	29
MRB3722	12 - 16 - 5/8"	1" -14 UNS -2B	56	29

FITTINGS FOR COMPACT HOSE
RACCORDI CON CAMPANA
SEZIONE RIDOTTA

MRB3706-R	06 - 08 - 5/16"	5/8" -18- UNF	47	19
MRB3708-R	08 - 10 -13/32"	3/4" -16- UNF	52	22
MRB3710-R	10 - 13 - 1/2"	7/8" -14 UNF	55	27

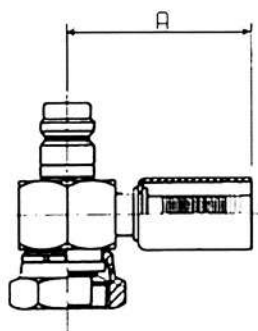

FITTINGS FOR STANDARD HOSE
RACCORDI CON CAMPANA
SEZIONE STANDARD

**CRIMP FITTING 90° ROTALOCK WITH VALVE
RACCORDO BLOCCHETTO A 90° CON VALVOLA**

CODICE CODE	TUBO HOSE	FILETTATURA THREADING	A	CH	VALVOLA VALVE
	size - dn - inch				
MRB3786	06 - 8 - 5/16"	5/8" -18- UNF	47	19	HP
MRB3788	08 - 10 -13/32"	3/4" -16- UNF	52	22	HP
MRB3798	08 - 10 -13/32"	1" -14 UNS -2B	55	29	HP
MRB3789	10 - 13 - 1/2"	7/8" -14 UNF	55	27	LP
MRB3800	10 - 13 - 1/2"	1" -14 UNS -2B	55	29	LP
MRB3802	12 - 16 - 5/8"	1" -14 UNS -2B	56	29	LP

FITTINGS FOR COMPACT HOSE
RACCORDI CON CAMPANA
SEZIONE RIDOTTA

MRB3786-R	06 - 8 - 5/16"	5/8" -18- UNF	47	19	HP
MRB3788-R	08 - 10 -13/32"	3/4" -16- UNF	52	22	HP
MRB3789-R	10 - 13 - 1/2"	7/8" -14 UNF	55	27	LP

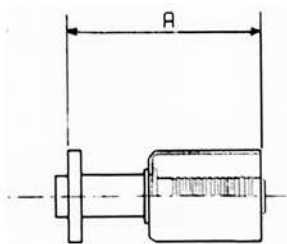

FITTINGS FOR STANDARD HOSE
RACCORDI CON CAMPANA
SEZIONE STANDARD

**CRIMP FITTING WITH COMPRESSOR FLANGE
RACCORDO CON FLANGIA PER COMPRESSORE**

CODICE CODE	TUBO HOSE	FILETTATURA THREADING	A
	size - dn - inch		
MRB3868	08 - 10 - 13/32"	13/32"	58
MRB3870	10 - 13 - 1/2"	1/2"	58

FITTINGS FOR COMPACT HOSE
RACCORDI CON CAMPANA
SEZIONE RIDOTTA

MRB3868-R	08 - 10 - 13/32"	13/32"	58
MRB3870-R	10 - 13 - 1/2"	1/2"	58

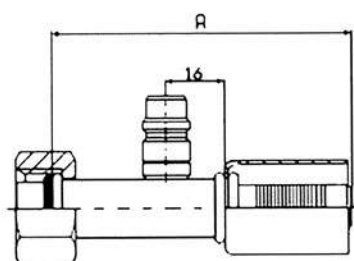

FITTINGS FOR STANDARD HOSE
RACCORDI CON CAMPANA
SEZIONE STANDARD

**CRIMP FITTING 180° FEMALE OR WITH VALVE
RACCORDO 180° FEMMINA OR CON VALVOLA**

CODICE CODE	TUBO HOSE	FILETTATURA THREADING	A	CH
	size - dn - inch			
MRB3607	06 - 8 - 5/16"	5/8"-18 UNF	66	HP
MRB3609	08 - 10 - 13/32"	3/4"-16 UNF	70	HP
MRB3611	10 - 13 - 1/2"	7/8"-14 UNF	77	LP

FITTINGS FOR COMPACT HOSE
RACCORDI CON CAMPANA
SEZIONE RIDOTTA

MRB3607-R	06 - 8 - 5/16"	5/8"-18 UNF	66	HP
MRB3609-R	08 - 10 - 13/32"	3/4"-16 UNF	70	HP
MRB3611-R	10 - 13 - 1/2"	7/8"-14 UNF	77	LP

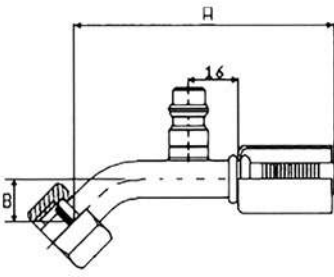

FITTINGS FOR STANDARD HOSE
RACCORDI CON CAMPANA
SEZIONE STANDARD

CRIMP FITTING 45° FEMALE OR WITH VALVE RACCORDO 45° FEMMINA OR CON VALVOLA

CODICE CODE	TUBO HOSE	FILETTATURA THREADING	A	B	VALVOLA VALVE
	size - dn - inch				
MRB3713	06 - 8 - 5/16"	5/8" - 18 UNF	80	12,5	HP
MRB3715	08 - 10 - 13/32"	3/4" - 16 UNF	88	13,5	HP
MRB3717	10 - 13 - 1/2"	7/8" - 14 UNF	99	24	LP

FITTINGS FOR COMPACT HOSE
RACCORDI CON CAMPANA
SEZIONE RIDOTTA

MRB3713-R	06 - 8 - 5/16"	5/8" - 18 UNF	80	12,5	HP
MRB3715-R	08 - 10 - 13/32"	3/4" - 16 UNF	88	13,5	HP
MRB3717-R	10 - 13 - 1/2"	7/8" - 14 UNF	99	24	LP

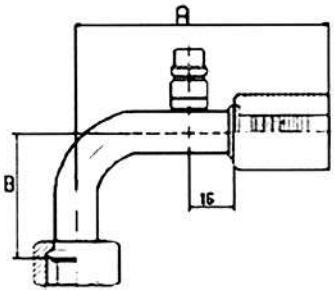

FITTINGS FOR STANDARD HOSE
RACCORDI CON CAMPANA
SEZIONE STANDARD

CRIMP FITTING 90° FEMALE OR WITH VALVE RACCORDO 90° FEMMINA OR CON VALVOLA

CODICE CODE	TUBO HOSE	FILETTATURA THREADING	A	B	VALVOLA VALVE
	size - dn - inch				
MRB3785	06 - 8 - 5/16"	5/8" - 18 UNF	80	12,5	HP
MRB3787	08 - 10 - 13/32"	3/4" - 16 UNF	88	13,5	HP
MRB3890	10 - 13 - 1/2"	7/8" - 14 UNF	99	24	LP

FITTINGS FOR COMPACT HOSE
RACCORDI CON CAMPANA
SEZIONE RIDOTTA

MRB3785-R	06 - 8 - 5/16"	5/8" - 18 UNF	80	12,5	HP
MRB3787-R	08 - 10 - 13/32"	3/4" - 16 UNF	88	13,5	HP
MRB3890-R	10 - 13 - 1/2"	7/8" - 14 UNF	99	24	LP

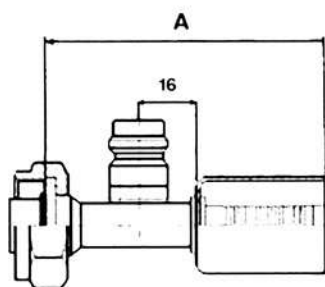

FITTINGS FOR STANDARD HOSE
RACCORDI CON CAMPANA
SEZIONE STANDARD

**CRIMP FITTING 180° FEMALE OR ROTALOCK WITH VALVE
RACCORDO 180° FEMMINA ROTALOCK CON VALVOLA**

CODICE CODE	TUBO HOSE	FILETTATURA THREADING	A	VALVOLA VALVE
	size - dn - inch			
MRB3878	08 - 10 - 13/32"	1"-14 UNS -2B	80	HP
MRB3880	10 - 13 - 1/2"	1"-14 UNS -2B	80	LP

FITTINGS FOR COMPACT HOSE
RACCORDI CON CAMPANA
SEZIONE RIDOTTA

MRB3878-R	08 - 10 - 13/32"	1"-14 UNS -2B	80	HP
MRB3880-R	10 - 13 - 1/2"	1"-14 UNS -2B	80	LP

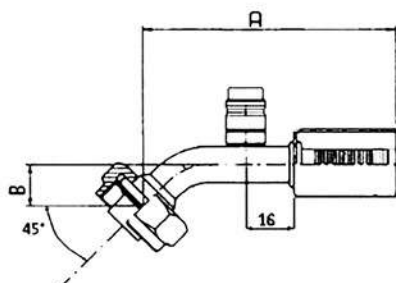

FITTINGS FOR STANDARD HOSE
RACCORDI CON CAMPANA
SEZIONE STANDARD

**CRIMP FITTING 45° FEMALE OR ROTALOCK WITH VALVE
RACCORDO 45° FEMMINA ROTALOCK CON VALVOLA**

CODICE CODE	TUBO HOSE	FILETTATURA THREADING	A	VALVOLA VALVE
	size - dn - inch			
MRB3758	08 - 10 - 13/32"	1"-14 UNS -2B	80	HP
MRB3760	10 - 13 - 1/2"	1"-14 UNS -2B	80	LP

FITTINGS FOR COMPACT HOSE
RACCORDI CON CAMPANA
SEZIONE RIDOTTA

MRB3758-R	08 - 10 - 13/32"	1"-14 UNS -2B	80	HP
MRB3760-R	10 - 13 - 1/2"	1"-14 UNS -2B	80	LP

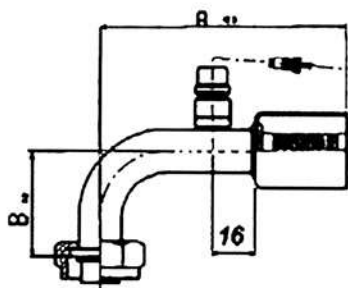

FITTINGS FOR STANDARD HOSE
RACCORDI CON CAMPANA
SEZIONE STANDARD

**CRIMP FITTING 90° FEMALE OR ROTALOCK WITH VALVE
RACCORDO 90° FEMMINA ROTALOCK CON VALVOLA**

CODICE CODE	TUBO HOSE	FILETTATURA THREADING	A	B	VALVOLA VALVE
	size - dn - inch				
MRB3768	08 - 10 - 13/32"	1" - 14 UNS - 2B	78	33	HP
MRB3770	10 - 13 - 1/2"	1" - 14 UNS - 2B	93	39	LP

FITTINGS FOR COMPACT HOSE
RACCORDI CON CAMPANA
SEZIONE RIDOTTA

MRB3768-R	08 - 10 - 13/32"	1" - 14 UNS - 2B	78	33	HP
MRB3770-R	10 - 13 - 1/2"	1" - 14 UNS - 2B	93	39	LP

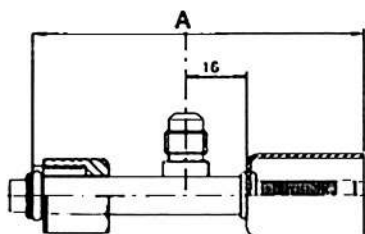

FITTINGS FOR STANDARD HOSE
RACCORDI CON CAMPANA
SEZIONE STANDARD

**FEMALE 180° FITTING R12 VALVE
RACCORDO 180° FEMMINA CON VALVOLA R12**

CODICE CODE	TUBO HOSE	FILETTATURA THREADING	A	VALVOLA VALVE
	size - dn - inch			
MRB3605	06 - 8 - 5/16"	5/8" - 18 UNF	86	R12 1/4" SAE

FITTINGS FOR COMPACT HOSE
RACCORDI CON CAMPANA
SEZIONE RIDOTTA

MRB3605-R	06 - 8 - 5/16"	5/8" - 18 UNF	86	R12 1/4" SAE
-----------	----------------	---------------	----	--------------

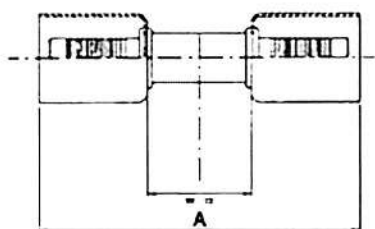

FITTINGS FOR STANDARD HOSE
RACCORDI CON CAMPANA
SEZIONE STANDARD

**CRIMP SPLICER 180°
GIUNZIONE 180° A CRIMPARE**

CODICE CODE	TUBO HOSE	A
	size - dn - inch	
MRB3696	06 - 8 - 5/16"	98
MRB3698	08 - 10 - 13/32"	98
MRB3700	10 - 13 - 1/2"	102
MRB3702	12 - 16 - 5/8"	102

FITTINGS FOR COMPACT HOSE
RACCORDI CON CAMPANA
SEZIONE RIDOTTA

MRB3696-R	06 - 8 - 5/16"	98
MRB3698-R	08 - 10 - 13/32"	98
MRB3700-R	10 - 13 - 1/2"	102
MRB3702-R	12 - 16 - 5/8"	102

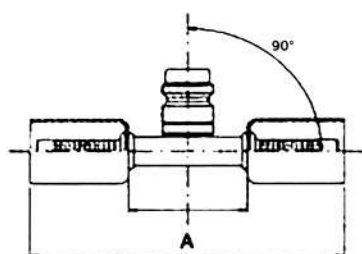

FITTINGS FOR STANDARD HOSE
RACCORDI CON CAMPANA
SEZIONE STANDARD

**CRIMP SPLICER 180° WITH VALVE
GIUNZIONE A 180° A CRIMPARE CON VALVOLA**

CODICE CODE	TUBO HOSE	A	VALVOLA VALVE
	size - dn - inch		
MRB3776	06 - 8 - 5/16"	98	HP
MRB3778	08 - 10 - 13/32"	98	HP
MRB3780	10 - 13 - 1/2"	102	LP
MRB3782	12 - 16 - 5/8"	102	LP

FITTINGS FOR COMPACT HOSE
RACCORDI CON CAMPANA
SEZIONE RIDOTTA

MRB3776-R	06 - 8 - 5/16"	98	HP
MRB3778-R	08 - 10 - 13/32"	98	HP
MRB3780-R	10 - 13 - 1/2"	102	LP
MRB3782-R	12 - 16 - 5/8"	102	LP

MAC-SERVICE



MAC-SERVICE



Hose Type	MAC-SERVICE
Application	AC SERVICE
Specification (qualifications list is not excluding further specs.)	SAE J2064 type C Barrier; SAE J2196 PAG/POE only; SAE J2888
Working Temp.	- 40 ÷ 125°C

Peak Temp.	150°C
Tube	EPDM-PA
Reinforcement	1 textile braid
Cover	CM
Key characteristics	<ul style="list-style-type: none"> - Low Permeability to Refrigerant Fluids; - Compatibility with a wide range of refrigerants such as R134a, R1234yf, R404a; - Very High Flexibility; - Oil Resistant cover

DIMENSIONS AND TOLERANCES

DN [mm] ID OD	Size [inch]	Hose ID [mm]		Hose OD [mm]		Max wall th. difference [mm]
		min	max	min	max	
5,8 x 12,5	1/4	5,5	6,1	12,0	13,0	0,6

TECHNICAL CHARACTERISTICS

DN (mm) ID OD	Working pressure [bar]	Burst pressure [bar]	Minimum bend radius [mm]	Weight [g/m]
5,8 x 12,5	52	>260	30	120

ARTIC NK



ARTIC NK



Hose Type	ARTIC NK
Application	AIR CONDITIONING SYSTEMS
Specification (qualifications list is not excluding further specs.)	AudiNW TL82316 & VW 50170; BMW QV64005; Daimler DBL6228 & A2118300600; (qualifications list is not excluding Delphi Thermal SD2-254; Fiat 9.93460-01; Ford S95UW-19B591-AA; GM 13003; furtherspecs.) Nissan 92480 NDS1 0; PSA 827-3010; Renault 32-02-017; SAE J2064; VTC TR 20817215; vcc 31803943/44
Working Temp.	- 40 ÷ 125°C
Peak Temp.	140°C
Tube	PA
Reinforcement	1 textile draid
Cover	EPDM
Key characteristics	<ul style="list-style-type: none"> - Low Permeability to Refrigerant Fluids;; - Compatibility with a wide range of refrigerants such as R134a, R1234yf, R404a; - Compact Dimensions; Low Weight; - High Flexibility; - Low Noise Transmission.

DIMENSIONS AND TOLERANCES

DN [mm] ID OD	Size [inch]	Hose ID [mm]		Hose OD [mm]		Max wall th. difference [mm]
		min	max	min	max	
8,0 x 12,7	5/16	7,8	8,2	12,5	13,1	0,4
10,5 x 16,0	13/32	10,3	10,7	15,7	16,3	0,4
12,7 x 18,1	1/2	12,4	13,0	17,7	18,5	0,5
16,0 x 21,7	5/8	15,7	16,3	21,4	22,0	0,5

TECHNICAL CHARACTERISTICS

DN (mm) ID OD	Working pressure [bar]	Burst pressure [bar]	Minimum bend radius [mm]	Weight [g/m]	Permeability to R134a@ 80°C [kg/m ² /y]
10,5 x 16,0	35	>170	50	140	< 0,5
12,7 x 18,1	20	>150	80	155	< 0,5
16,0 x 21,7	20	>150	90	200	< 0,7

Maflow BRS S.r.l.

Legal and Administrative Office/ Operation:
Via Mutilati del Lavoro, Z.Ind.le Campolungo
63100 Ascoli Piceno – Italy

 **desk:** +39 0736 225 781  **mobile:** +39 366 4759179

 **e-mail:** cinzia.loffreda@maflow.com



MAFLOW
member of **BORYSZEW GROUP** 

m a f l o w . c o m